



Box Camera Series Hardware Manual

A21, A23, A24, A28, A29, A213

2024/02/05



ACTi
Connecting Vision

Table of Contents

Precautions4

Safety Instructions	6
---------------------------	---

Introduction.....7

The List of Models	7
Package Contents	8
Physical Description	9
Mounting Options	11

Indoor Installation Procedures 12

Step 1: Attach the Camera Lens	12
Step 2: Mount the Indoor Bracket.....	13
Step 3: Attach the Camera to the Bracket.....	14
Step 4: Connect the Cable(s).....	16
Step 5: Access the Camera Live View.....	16
Step 6: Adjust the Viewing Angle and Focus.....	16

Other Connections (Optional) 17

How to Connect DI/DO and Audio Devices	17
How to Connect DI/DO Devices	17
DI/DO Connection Specifications.....	18
How to Connect Audio Devices	20
How to Connect a Power Adapter	21
How to Connect a Serial Device	23

Other Adjustments and Accessories24

How to Adjust the Viewing Angle and Focus (A23, A24)..... 24

How to Install / Remove the Memory Card 25

 How to Insert the Memory Card 25

 How to Remove the Memory Card 25

Accessing the Camera.....26

Configure the IP Addresses..... 26

Access the Camera 30

Precautions

Read these instructions

You should read all the safety and operating instructions before using this product.

Heed all warnings

You must adhere to all the warnings on the product and in the instruction manual. Failure to follow the safety instruction given may directly endanger people, cause damage to the system or to other equipment.

Servicing

Do not attempt to service this video device yourself as opening or removing covers may expose you to dangerous voltage or other hazards. Refer all servicing to qualified service personnel.

Trademarks

All names used in this manual are probably registered trademarks of respective companies.

Liability

Every reasonable care has been taken during the writing of this manual. Please inform your local office if you find any inaccuracies or omissions. We cannot be held responsible for any typographical or technical errors and reserve the right to make changes to the product and manuals without prior notice.

Federal Communications Commission Statement

This device complies with Part 15 of the FCC Rules. Operation is subject to the following two conditions:

1. This device may not cause harmful interference.
2. This device must accept any interference received, including interference that may cause undesired operation.

Note: This equipment has been tested and found to comply with the limits for a Class A digital device, pursuant to Part 15 of the FCC Rules. These limits are designed to provide reasonable protection against harmful interference when the equipment is operated in a commercial environment. This equipment generates, uses, and can radiate radio frequency energy, and if it is not installed and used in accordance with the instruction manual, it may cause harmful interference to radio communications. Operation of this equipment in a residential area is likely to cause harmful interference, in which case the user will be required to correct the interference at their own expense.

European Community Compliance Statement



This product has been tested and found to comply with the limits for Class B Information Technology Equipment according to European Standard EN 55022 and EN 55024. In a domestic environment, this product may cause radio interference in which cause the user may be required to take adequate measures.

Safety Instructions

Cleaning

Disconnect this video product from the power supply before cleaning.

Attachments

Do not use attachments not recommended by the video product manufacturer as they may cause hazards.

Installation

Install this device as well as other devices (such as PoE injector, alarm, etc.) in a dry place protected from weather.

Servicing

Do not attempt to service this video product yourself. Refer all servicing to qualified service personnel.

Damage Requiring service

Disconnect this video product from the power supply immediately and refer servicing to qualified service personnel under the following conditions.

- 1) When the power-supply cord or plug is damaged
- 2) If liquid has been spilled, or objects have fallen into the video product.
- 3) If the inner parts of video product have been directly exposed to rain or water.
- 4) If the video product does not operate normally by following the operating Instructions in this manual. Adjust only those controls that are covered by the instruction manual, as an improper adjustment of other controls may result in damage, and will often require extensive work by a qualified technician to restore the video product to its normal operation.

Safety Check

Upon completion of any service or repairs to this video product, ask the service technician to perform safety checks to determine if the video product is in proper operating condition.

Introduction





The List of Models

This hardware manual contains the following models:

A21		3MP Box with D/N, Extreme WDR, SLLS, Fixed lens
A22		5MP Box with D/N, Extreme WDR, SLLS, Fixed lens
A23		3MP Box with D/N, Extreme WDR, SLLS, Vari-focal lens
A24		5MP Box with D/N, Extreme WDR, SLLS, Vari-focal lens
A28		2MP Box with D/N, Extreme WDR, ELLS, Fixed lens
A29		2MP Box with D/N, Extreme WDR, ELLS, Fixed lens
A213		5MP Face, People and Car Detection Box with D/N, Extreme WDR, ELLS, Fixed lens

From the installation perspective, these models are very similar; therefore one manual is used for all of them.

Package Contents

Camera	Lens (A21, A23, A28, A29, A213)	Lens (A24)
		
Terminal Block	Warranty Card	
	<div style="border: 1px solid black; padding: 10px; text-align: center;">Warranty Card</div>	

NOTE: The pictures are for reference only; actual items may slightly vary in appearance.

Physical Description



	Item	Description
1	DC 12V Power Input	In case the camera is connected to a non-PoE (Power over Ethernet) switch, use this connector to connect the camera to an external power adapter (not included) to power up the camera. This connector can also be used to power up a digital output device.
	Digital Input / Output (DI/DO)	This connector connects to digital input or output devices, such as an alarm trigger, panic button, etc. Digital Input (DI) and Digital Output (DO) devices are used in applications like motion detection, event triggering, alarm notifications, etc.
	Audio Input / Output	This connector connects to audio input and output devices, such as microphones and speakers.
	Serial Port	Connects to a serial port device, such as a PT scanner (sold separately), using the RS-485 protocol. Use the supplied terminal block to connect the wires from the serial device to the camera.
2	Ethernet Port	Connects to a network using an Ethernet cable.
3	Video Output	Connects to an analog video output device with BNC connector. NOTE: Not available on A28, A29, A213 models.
4	Memory Card Slot	Insert a memory card into this slot for local recording purposes. . See How to Install /

Item		Description
		<p><i>Remove the Memory Card</i> on page 25 for more information.</p> <p>NOTE: Supports microSDHC and microSDXC cards.</p>
5	Reset Button	Restores the factory default settings of the camera. Using a pointed object, such as a paper clip, press and hold the reset button for at least 5 seconds.

Mounting Options

The camera can be installed both indoors and outdoors. For outdoor installation, additional waterproof housing is required. Below are several mounting options that you can use to install the camera. Select the most suitable solution for your installation environment.

Mount Types	Accessories
Ceiling or Wall (Indoor)	You may use the bracket from a local supplier or purchase ACTi's indoor bracket. See Indoor Installation Procedures on page 12 for more information.
Wall (Outdoor)	A waterproof housing is required when installing the camera outdoors.
Pole Mount	Suitable when mounting the camera on vertical poles. The camera must be enclosed inside the waterproof housing.
Corner Mount	Suitable when mounting the camera on a corner wall. The camera must be enclosed inside the waterproof housing.

NOTE:

- For more information about the mounting solutions and accessories, please check the [Mounting Accessory Selector](http://www.acti.com/mountingselector) in our website (<http://www.acti.com/mountingselector>).
- The above mounting accessories are not included in the package. Contact your sales agents to purchase.

Indoor Installation Procedures

This section describes the procedures in installing the camera indoors using PMAX-1105 indoor bracket (purchased separately).

When using brackets from other manufacturers, check the installation guide included in the bracket to install the camera. Similar procedures apply when using brackets from other camera manufacturers.

NOTE: Some pictures in this documentation only show one type of camera lens; this means that the procedures are applicable to other types of lens, unless specified otherwise.

Step 1: Attach the Camera Lens

NOTE: To avoid scratches or leaving fingerprints on the lens, it is recommended to retain the protective cap covering the lens until the camera is completely installed.

1. Unpack the camera and check the bundled camera lens.
2. Unscrew the cap covering the camera lens holder.



3. Attach the lens to the camera.



4. For cameras models A23 and A24, connect the lens cable to the iris port.



Step 2: Mount the Indoor Bracket

NOTE:

- The indoor bracket is not included in the camera package and must be purchased separately.
- The pictures on the succeeding pages are for reference only, camera labels and appearance may vary depending on camera model.

Before installing the bracket, make sure the ceiling or wall can bear more than the weight of the camera and its accessories.

Install the indoor bracket to the ceiling or wall using the three (3) screws included in the bracket package.



Step 3: Attach the Camera to the Bracket

NOTE: The following images show the mounting bracket attached on the bottom side of the camera. Same procedures apply when attaching the mounting bracket on the top side.

1. If necessary, insert a memory card into the memory card slot of the camera with the metal contacts facing the Reset button. Push until the card clicks into place. See [How to Install / Remove the Memory Card](#) on page 25 for more information.



2. Slightly loosen the knurled knob.



3. Screw the camera to the bracket.



4. Tighten the hand knob until the camera is secured to the bracket.



5. Adjust the camera angle.



6. Tighten the knurled knob to fix the camera position.



Step 4: Connect the Cable(s)

1. Connect the network cable to the Ethernet port of the camera.
2. If necessary, connect audio input/output or DI/DO devices to the camera. See [How to Connect DI/DO and Audio Devices](#) on page 17 for more information.
3. Connect the other end of the network cable to a switch or injector. Then, connect the switch or injector to a network, PC and a power source. See Power-over-Ethernet (PoE) connection example below.

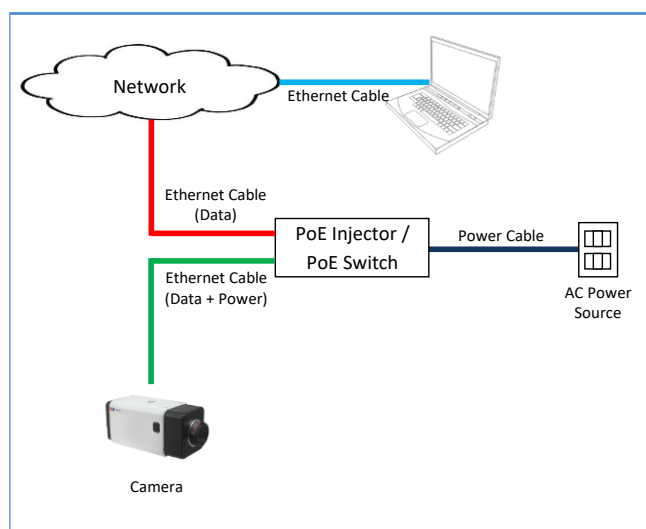

Step 5: Access the Camera Live View

See [Accessing the Camera](#) on page 26 for more information on how to access the Live View of the camera.

Step 6: Adjust the Viewing Angle and Focus

Based on the live view, adjust the focus and the viewing angle of the camera. Adjustments vary depending on model, for detailed information, see [How to Adjust the Viewing Angle and Focus \(A23, A24\)](#) on page 24.

Other Connections (Optional)

This section describes the procedures in preparing the external devices that you can connect to the camera. The camera supports Digital Input and Output (DI/DO), Audio Input and Output devices, analog video output, and DC12V power input that can be connected to the camera using the bundled terminal blocks. The use of these devices, however, is optional.

How to Connect DI/DO and Audio Devices

Depending on your surveillance needs, you may connect digital input / output or audio input / output devices to your camera. The camera comes with one (1) terminal block.

How to Connect DI/DO Devices

Digital Input (DI) devices can be used to notify the camera about an activity in the camera site. DI can be triggers of events. For example, you can connect a “panic button” to the camera; as such when the panic button is pressed, the alarm signal will be sent through the camera. Other common DI device applications are emergency button, smoke detector, passive infrared sensor, etc.

Digital Output (DO) devices are external devices that are activated by the camera upon an event inside the camera. For example, you can connect an “alarm horn” to the camera; as such when an event occurs inside the camera (e.g. detected intruder), the alarm horn will sound. Other common DO device applications are motion-triggered lights, electric fence, magnetic door locks, etc.

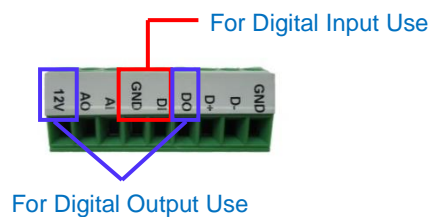

1. To connect digital input / output devices (DI/DO), map the pins to one of the pin combinations below:

Device	Pin	Mapping Instructions
Alarm Out or Digital Output (DO)	12V	Connect the wires of the output device to 12V and DO.
	DO	
Digital Input (DI)	GND	Connect the wires of the input device to GND and DI.
	DI	

2. After mapping the pins, connect the terminal block to the I/O connector of the camera.

DI/DO Connection Specifications

The table below shows the DI/DO connection specifications:

Device			
DI	Connection design		TTL - compatible logic levels
	Voltage	To trigger (low)	Logic level 0: 0V ~ 0.6V
		Normal (high)	Logic level 1: 2.8V ~ 5V
	Current		10mA ~ 100mA
DO	Connection design		Transistor (Open Collector)
	Voltage & Current		< 24V DC, < 100mA

Typical Connection

Based on these specifications, if the DI device has a voltage of 0V ~ 5V or the DO device has a voltage of < 24V (< 100mA), then the camera can supply internal power to these devices and there is no need to connect the DI/DO device to an external power source.

Use the GND and DI pins to connect a DI device and use the 12V and DO pins to connect a DO device. See wiring scheme below:

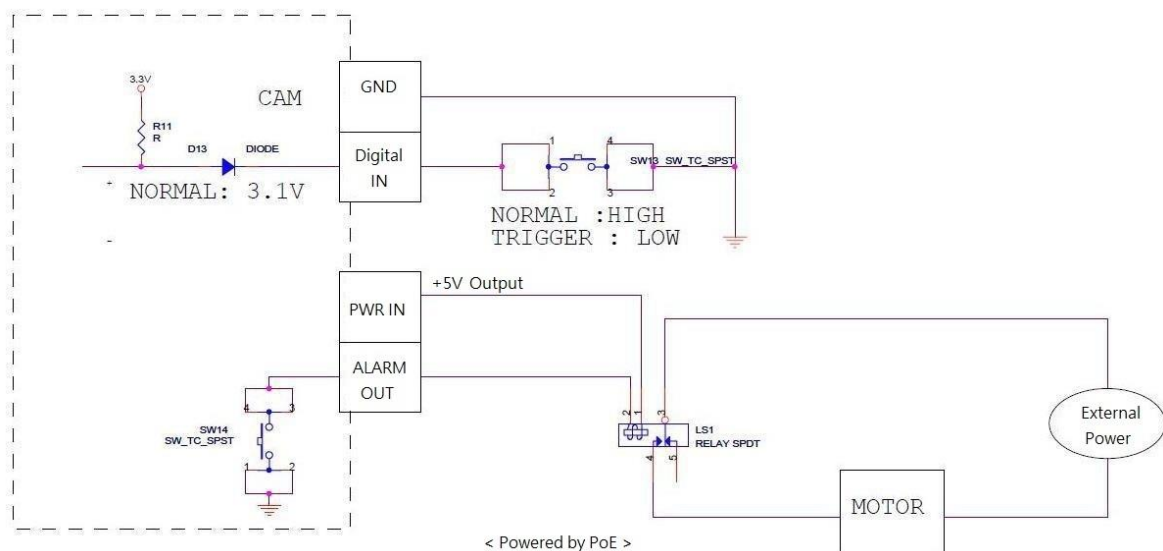

NOTE: If the camera is powered up by PoE, the DC12V connector can only provide DC 5V of power to a digital output device.

High Voltage DO Device Connection

For high voltage DO devices, such as a ceiling light or a motor that opens or closes a gate, there is a need to connect an external relay. See wiring scheme below:

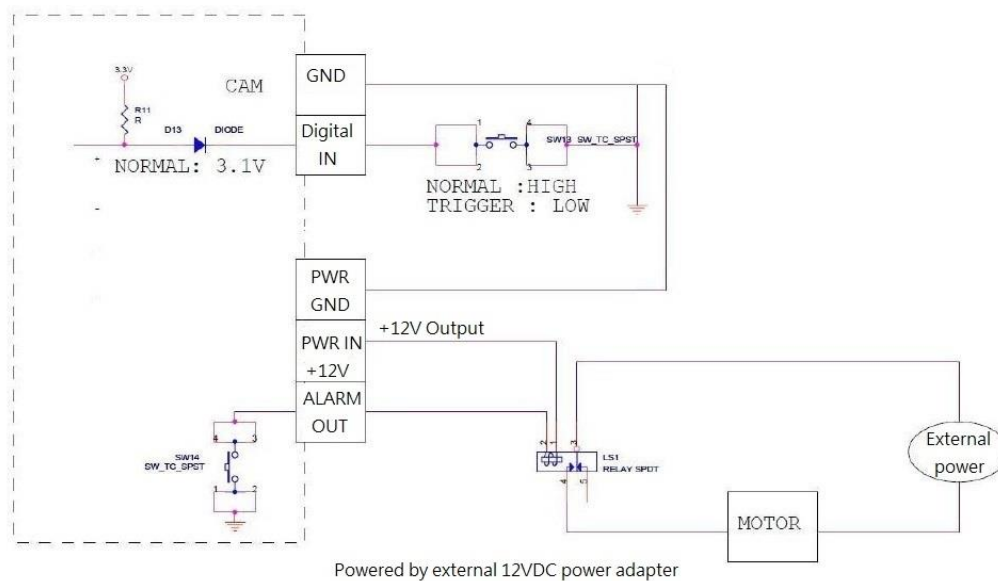

Note that when choosing an appropriate relay, please refer to its specifications and make sure they match the above design. The triggering circuit voltage has to be around 12V DC and the switch-controlled circuit voltage has to match the external power supply (e.g. 110V AC or 220V AC).

The illustration below is a graphic example of connecting a relay to a high voltage DO device.

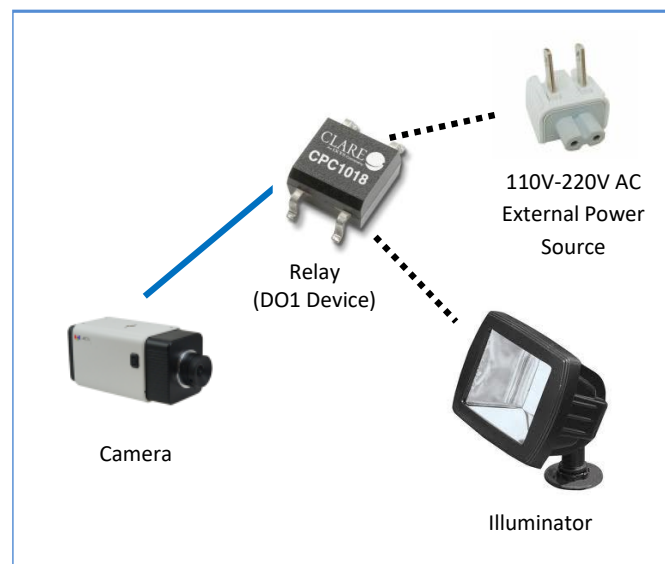

NOTE: For more information on DI/DO connections, please refer to the Knowledge Base article [All About Digital Input and Digital Output](#) downloadable from the link below (<http://Download.acti.com?id=516>).

How to Connect Audio Devices

Audio input / output devices, such as an active microphone or speaker can be connected to the camera using the supplied terminal block.

1. Map audio device wires through the pin slot on the supplied terminal block.

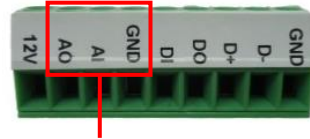

For Audio Use

2. To connect audio devices, map the pins to one of the pin combinations below:

Device	Pin	Mapping Instructions
Audio Output (AO)	GND	Connect the wires of the audio output device to GND and AO.
	AO	
Audio Input (A1)	GND	Connect the wires of the audio input device to GND and AI.
	AI	

NOTE: For more information about AUDIO in connections, please refer to the Knowledge Base article [How to Use Audio-in of ACTi Cameras](http://Download.acti.com?id=534), downloadable from the link below (<http://Download.acti.com?id=534>).

3. When ready, connect the terminal block to the I/O connector of the camera.

How to Connect a Power Adapter

In case of using a non-PoE switch or your PoE switch has limited power supply, you can purchase a power adapter and directly connect the camera to a power outlet. The power adapter must be connected to the supplied terminal block before use.

To do this, follow the procedures below:

1. Loosen the screws of the 12V and GND pins of the power terminal block.

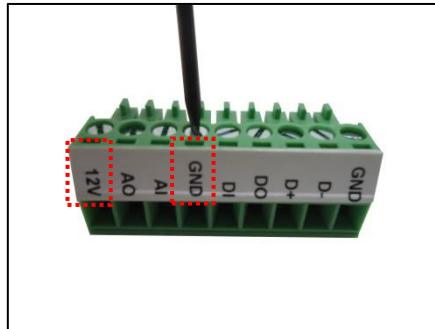

2. Take note that a standard power adapter cable has two (2) different wires:

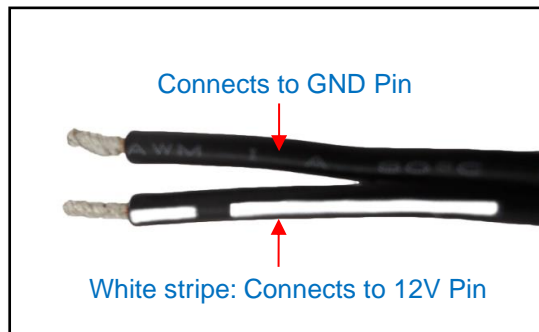

3. Connect the wire with the white stripe to the 12V pin and the other to the GND pin.

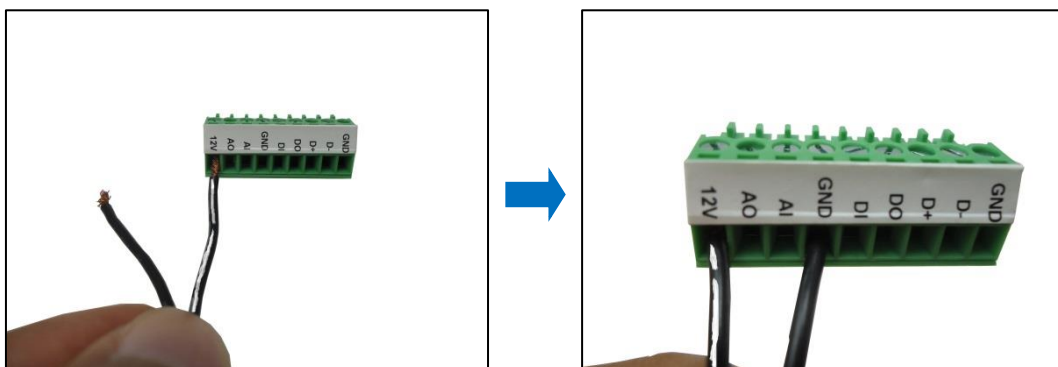

NOTE: The terminal block pictures are for reference only, note that actual label placement may vary per model.

4. Tighten the screws of the 12V pin and the GND pins to secure the wire connection.

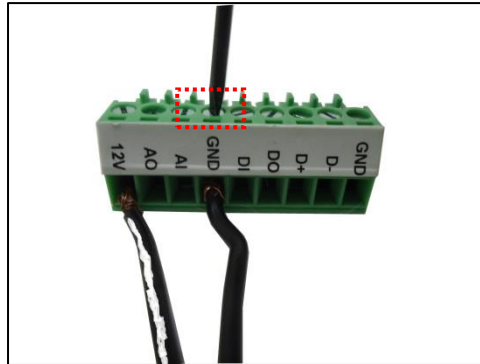

5. When ready, connect the prepared power adapter to the POWER connector of the camera.
Below is an example of a power adapter with an attached terminal block.



NOTE: The power adapter is not bundled in the package.

How to Connect a Serial Device

The camera can be connected to a Pan-Tilt (PT) Scanner (Pan-Tilt Head) using the serial port connector. This allows the zoom camera to do pan and tilt using the Pelco-D protocol. Most PT scanners accept Pelco-D and Pelco-P protocol commands via RS-485 connection, which are both supported by your camera.

Check the connection available on the PT scanner and connect it to your camera following the procedures below.

1. Map the wires from the PT scanner to your camera using the supplied terminal block according to the table below.

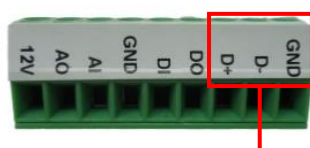

For Serial Port Use

Via RS-485 Connection

Terminal Block Label	Wire Mapping	
	Camera Pin	PT Scanner Pin
GND	GROUND PIN	
D-	RS485 D-	DATA- (TX-)
D+	RS485 D+	DATA+ (TX+)

NOTE: The pins of the PT Scanner may be labeled differently depending on the location or country where the scanner is purchased. For example, some PT devices may have RS-485 DATA+ pins labeled as “TX+”, “RX+”, “A” or “485+”, etc. Refer to the scanner documentation or contact the manufacturer to verify the corresponding pin labels and ensure proper wiring connection.



CAUTION: Incorrect wiring may cause damage to the connected devices.

DISCLAIMER: ACTi will not be responsible for any damage caused by improper wiring.

2. Connect a ground wire to one of the GND terminal pin to complete the connection.
3. After mapping the pins, connect the terminal block to the Serial Port connector of the camera.

Other Adjustments and Accessories

How to Adjust the Viewing Angle and Focus (A23, A24)

This section describes the procedures in adjusting the viewing angle and focus of the vari-focal cameras. The camera already comes pre-focused when you take it out the box. In case there is a need to modify the default focus and viewing angle, do the procedures below to make the necessary adjustments.

1. Loosen the zoom lever screw, then turn left or right to adjust the viewing angle.



2. Loosen the focus lever screw, then turn left or right to adjust the focus.



3. When done, tighten the lever screws to fix their position.



How to Install / Remove the Memory Card

The camera supports local video recording or saving of snapshots to a memory card.

NOTE: Supports microSDHC and microSDXC cards.

How to Insert the Memory Card

Insert a memory card into the card slot with the metallic contacts facing down the camera. Push the card until it clicks into place.



How to Remove the Memory Card

In case there is a need to remove the card, make sure to access the camera Web Configurator to safely “unmount” the card first (see the camera Firmware manual for more information). Once unmounted from the firmware, push the card to eject it from the slot.

Accessing the Camera

Configure the IP Addresses

In order to be able to communicate with the camera from your PC, both the camera and the PC have to be within the same network segment. In most cases, it means that they both should have very similar IP addresses, where only the last number of the IP address is different from each other. There are 2 different approaches to IP Address management in Local Area Networks – by DHCP Server or Manually.

Using DHCP server to assign IP addresses:

If you have connected the computer and the camera into the network that has a DHCP server running, then you do not need to configure the IP addresses at all – both the camera and the PC would request a unique IP address from DHCP server automatically. In such case, the camera will immediately be ready for the access from the PC. The user, however, might not know the IP address of the camera yet. It is necessary to know the IP address of the camera in order to be able to access it by using a Web browser.

The quickest way to discover the cameras in the network is to use the simplest network search, built in the Windows system – just by pressing the “Network” icon, all the cameras of the local area network will be discovered by Windows thanks to the UPnP function support of our cameras.

In the example below, we successfully the camera model that we had just connected to the network.

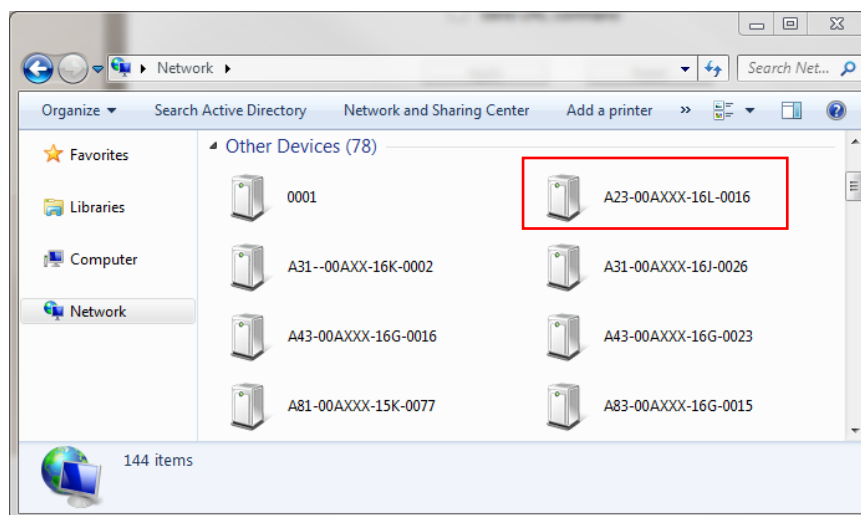

Double-click the mouse button on the camera model, the default browser of the PC is automatically launched and the IP address of the target camera is already filled in the address bar of the browser.

If you work with our cameras regularly, then there is even a better way to discover the cameras in the network – by using IP Utility. The IP Utility is a light software tool that can not only discover the cameras, but also list lots of valuable information, such as IP and MAC addresses, serial numbers, firmware versions, etc, and allows quick configuration of multiple devices at the same time.

Search and download IP Utility for free from <http://www.acti.com/DownloadCenter>.

With just one click, you can launch the IP Utility and there will be an instant report as follows:

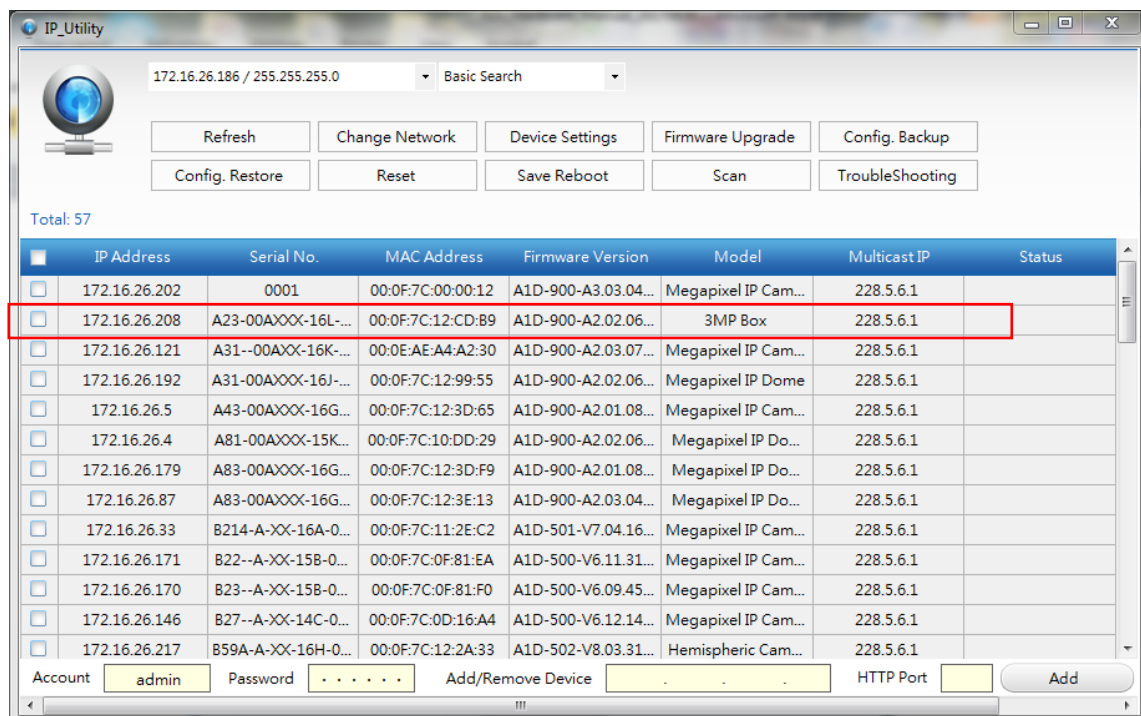

You can quickly notice the camera model in the list. Click on the IP address to automatically launch the default browser of the PC with the IP address of the target camera filled in the address bar of the browser already.

Use the default IP address of a camera:

If there is no DHCP server in the given network, the user may have to assign the IP addresses to both PC and camera manually to make sure they are in the same network segment.

When the camera is plugged into network and it does not detect any DHCP services, it will automatically assign itself a default IP:

192.168.0.100

Whereas the default port number would be 80. In order to access that camera, the IP address of the PC has to be configured to match the network segment of the camera.

Manually adjust the IP address of the PC:

In the following example, based on Windows 7, we will configure the IP address to 192.168.0.99 and set Subnet Mask to 255.255.255.0 by using the steps below:

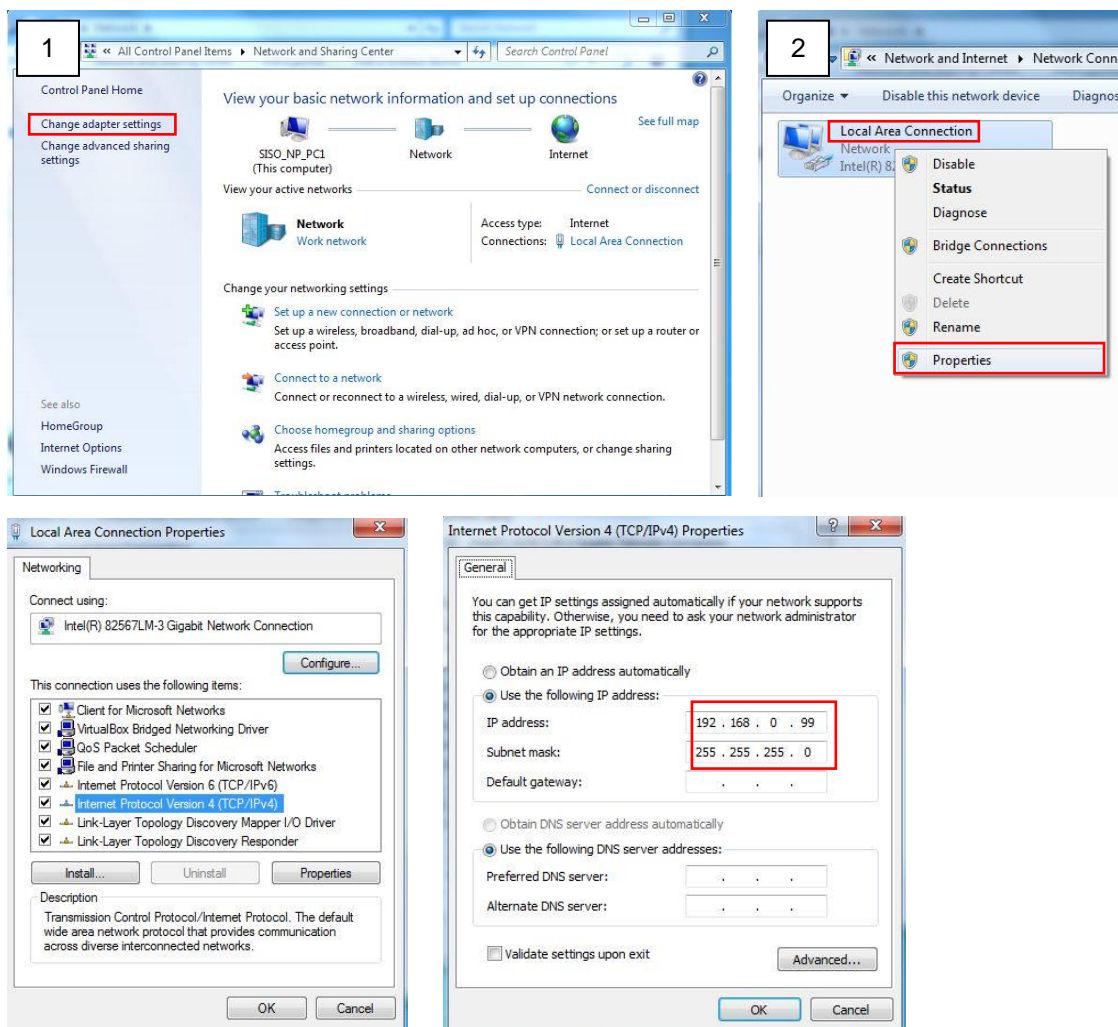

Manually adjust the IP addresses of multiple cameras:

If there are more than 1 camera to be used in the same local area network and there is no DHCP server to assign unique IP addresses to each of them, all of the cameras would then have the initial IP address of 192.168.0.100, which is not a proper situation for network devices – all the IP addresses have to be different from each other. The easiest way to assign cameras the IP addresses is by using IP Utility:

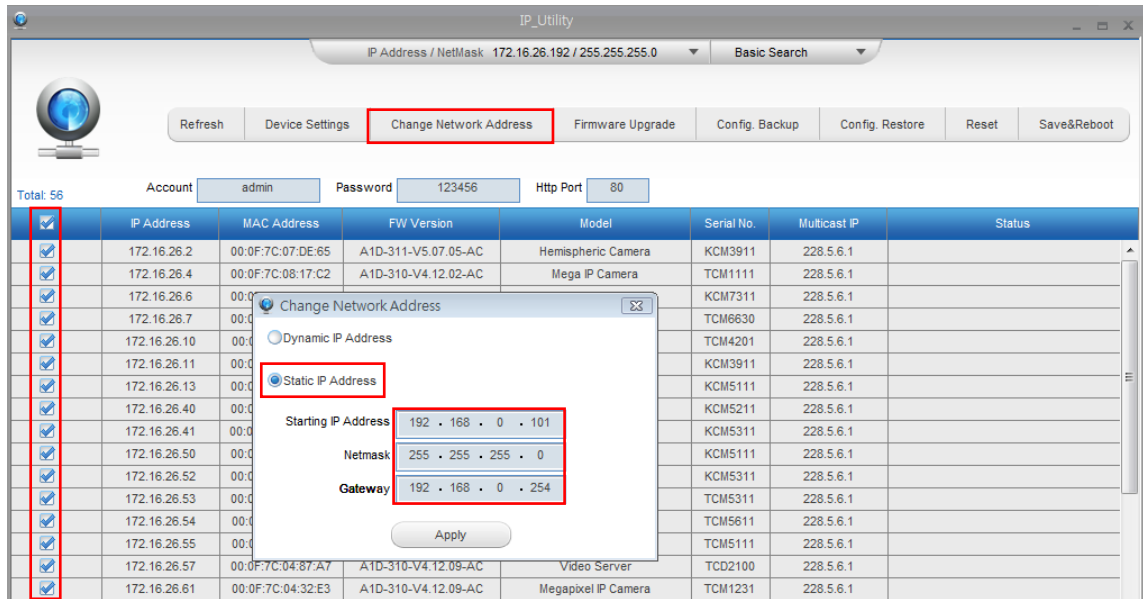

With the procedure shown above, all the cameras will have unique IP addresses, starting from 192.168.0.101. In case there are 20 cameras selected, the last one of the cameras would have the IP 192.168.0.120.

Later, by pressing the “Refresh” button of the IP Utility, you will be able to see the list of cameras with their new IP addresses.



Please note that it is also possible to change the IP addresses manually by using the Web browser. In such case, please plug in only one camera at a time, and change its IP address by using the Web browser before plugging in the next one. This way, the Web browser will not be confused about two devices having the same IP address at the same time.

Access the Camera

Now that the camera and the PC are both having their unique IP addresses and are under the same network segment, it is possible to use the Web browser of the PC to access the camera.

You can use Edge, Chrome or Firefox to access the camera.

An ActiveX control for video stream management will be downloaded from the camera directly – the user has to accept the use of such control when prompted so. No other third party utilities are required to be installed in such case.

Assuming that the camera's IP address is 192.168.0.100, you can access it by opening the Web browser and typing the following address into Web browser's address bar:

http://192.168.0.100

Upon successful connection to the camera, the user interface called Web Configurator would appear together with the login page. The HTTP port number was not added behind the IP address since the default HTTP port of the camera is 80, which can be omitted from the address for convenience.

Before logging in, you need to setup the root Account and Password of the camera.

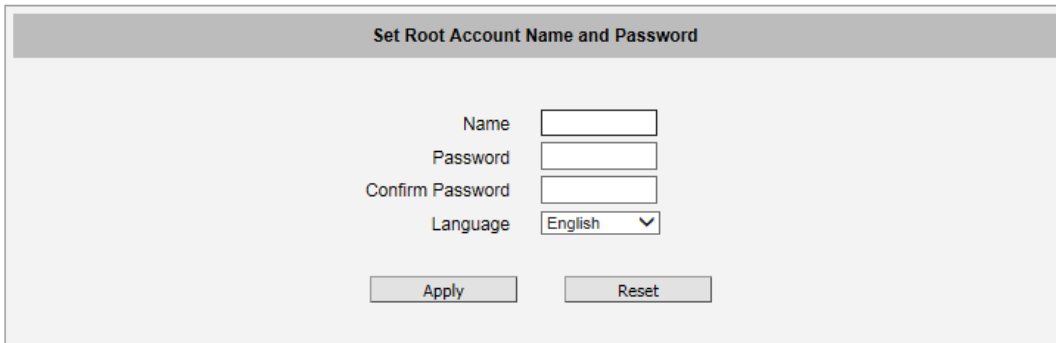

Set Root Account Name and Password

Name

Password

Confirm Password

Language

Then use this newly setup Account and Password to login to the Web Configurator.

For further operations, please refer to the Firmware User Manual.



Copyright © 2017, ACTi Corporation All Rights Reserved

7F, No. 1, Alley 20, Lane 407, Sec. 2, Ti-Ding Blvd., Neihu District, Taipei, Taiwan 114, R.O.C.

TEL : +886-2-2656-2588 FAX : +886-2-2656-2599

Email: sales@acti.com