

# A87

## 5MP Outdoor Zoom Dome with D/N, Adaptive IR, Advanced WDR, SLLS, 4.3x Zoom Lens



- 5 Megapixel
- Day & Night with Superior Low Light Sensitivity and Adaptive IR LED
- 4.3x Zoom Lens with f2.8-12mm/F1.4-F2.8, DC iris, Auto focus (for installation)
- Advanced WDR
- H.265 Compression
- Event trigger, response and notification

### ► Specifications

#### Device

Product Type	Zoom Dome
Maximum Resolution	5MP
Application Environment	Outdoor
Image Sensor	Progressive Scan CMOS
Sensor Size	1/2.9 "
Effective Pixels	3096(H) X 2202(V) (6.82 MP)
Day / Night	Yes
Low Light Sensitivity	Superior
Minimum Illumination	Color: 0.15 lux; B/W: 0 lux (IR LED on)
Color to B/W Switch	ISP based switch, configurable
Mechanical IR Cut Filter	Yes
IR Sensitivity Range	700-1150nm
IR LED	Adaptive IR LED
IR Working Distance	30m
Horizontal Resolution (TV Lines)	1300 TVL

S/N Ratio	56 dB
-----------	-------

## Lens

Focal Length	Zoom, f2.8-12mm
Aperture	F1.4-F2.8
Zoom Ratio	4.3x optical
Zoom Application	Camera Installation
Iris	DC iris
Focus	Auto focus
Lens Mount	Board mount
Horizontal Viewing Angle	71° - 25°
Viewing Angle Adjustment	Pan: ±135°, Tilt: 0°-90°, Rotation: ±90°

## PTZ

Pan, Tilt or Zoom protocol	Pelco-D, Pelco-P, ACTi URL command
----------------------------	------------------------------------

## Video

Compression	H.265, H.264 (Baseline/ Main/ High profile), MJPEG
Maximum Frame Rate vs. Resolution	30 fps at 2592 x 1944 30 fps at 2048 x 1536 30 fps at 1920 x 1080 30 fps at 1280 x 960 30 fps at 1280 x 720 30 fps at 800 x 600 30 fps at 720 x 480 30 fps at 640 x 480 30 fps at 320 x 240
Multi-Streaming	Simultaneous triple streams based on three configurations
Bit Rate	128Kbps - 20Mbps (per stream)
Bit Rate Mode	Constant, Variable
Wide Dynamic Range	Advanced WDR (120 dB)
Image Enhancement	White Balance, Brightness, Contrast, Sharpness, Automatic gain control, Flickerless, Digital Image Stabilizer (DIS, EIS), Defogging
Digital Noise Reduction	2D + 3D DNR
Privacy Mask	4 configurable regions
Text Overlay	Yes
On-Screen Graphics	Yes
Built-in Analytics	Tampering Detection
Server-based Analytics	Object Line Counting, People Counting, Face Detection, Object Based Motion Detection, Tamper, Object Line Crossing Detection, Object Enter Area Detection, Missing Object Detection, Unattended Object Detection, Smoke Detection, Heat Map, Dwell Time, Direction Detection, Automatic License Plate Recognition, People Queue Detection, (Require PC-based or standalone IVS or ALPR Server. Contact ACTi support for recommendations on how to maximize analytical accuracy)
Image Orientation	Flip, Mirror, Rotation (Corridor mode)

## Audio

Audio Type	2-way, Mic-in, Line-in, Line-out
Audio Compression	8 kHz, Mono, G.711

## Network

Network Protocol & Service	IPv4/v6, TCP, UDP, DHCP, PPPoE, HTTP, HTTPS, DNS, DDNS, NTP, RTP, RTSP, RTCP, SMTP, FTP, IGMP, ICMP, ARP, Bonjour, UPnP, QoS, SNMP
Ethernet Port	1 x RJ-45 connector
Security	IP address filtering, HTTPS encryption, Password protected user level, Anonymous login

## Event

Event Trigger	Video motion detection (3 regions), External device through digital input, Sound detection, Tampering detection, Video streams loss
Event Response	Notify control center, Change camera settings, Command other devices, E-mail notification with snapshots, Push notification to mobile device, Save video to local storage, Upload video or snapshot to FTP server, Activate external device through digital output

## Integration

Unified Solution	Fully compatible with ACTi software
GPS Position	Manual setting
ONVIF Compliant	Yes, Profile S, Profile G, Profile T, Profile Q
Web Browser	IE 11

## Interface

Audio Interface	Terminal block
Analog Video Output	1 x CVBS, Terminal block, for installation only
Local Storage	MicroSDHC, MicroSDXC Memory Card Slot (card not included, up to 256GB)
Digital Input/Output	1/1 (Terminal block), DC Output Voltage: 5V
Operating Button	Reset Button

## General

Power Source	DC 12V, PoE Class 3 (IEEE802.3af)
Power Consumption	10 W (PoE, IR on), 8 W (DC, IR on)
Weight	858g (1.892lb)
Dimensions	(Ø x H): 139.38mm x 129.75mm (5.48" x 5.10")
Environmental Casing	Weatherproof (IP66), Vandal proof (IK10)
Mount Type	Surface, Pendant, Wall Mount
Starting Temperature	-20°C ~ 50°C (-4°F ~ 122°F)
Operating Temperature	-40°C ~ 50°C (-40°F ~ 122°F)
Operating Humidity	20% - 80% RH
Approvals	CE Class A, FCC Class A, EAC, CB, UL Listed (UL 62368-1), IP66, NEMA 4X, IK10
Real-time Clock (RTC)	Yes
Warranty	3 Year(s). For extended warranty offering, see <a href="http://www.acti.com/support/warranty">http://www.acti.com/support/warranty</a>

## ► Photo Indication

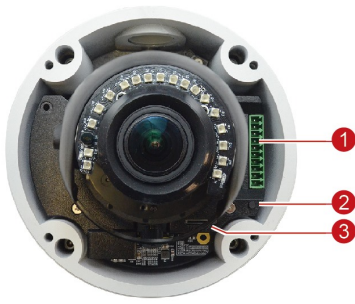

- 1 Input and Output Connector
  - DC 12V Power Input
  - Digital Input / Output
  - Audio Input / Output
  - Analog Video Output
- 2 Reset Button
- 3 Memory Card Slot
- 4 Ethernet Port



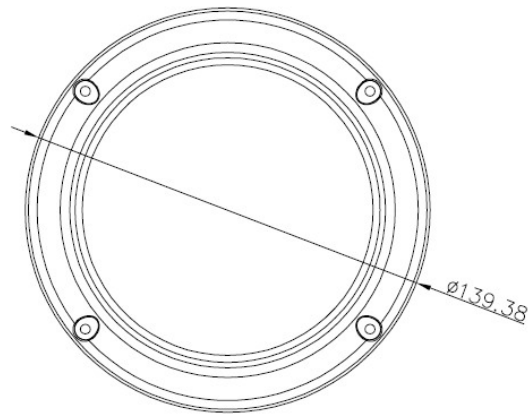
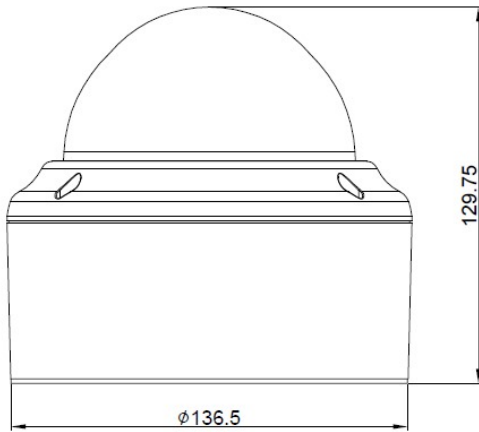















## ► Dimension Diagram



Unit: mm [inch]

## ▶ Related Products

### Mounting Accessories - Camera Mount

PMAX-0102		Straight Tube
PMAX-0103		Straight Tube with Bracket
PMAX-0104		Extension Tube
PMAX-0113		Pendant Mount (for A8x, except A88)
PMAX-0114		Mount Kit for Dome Cameras (for A8x, except A88)
PMAX-0302		Gooseneck with Bracket
PMAX-0303		Gooseneck
PMAX-0321		Heavy Duty Wall Mount for Outdoor Domes (for A8x, Z83, Z84, except A88)
PMAX-0333		Wall Mount (for A8x, except A88)
PMAX-0402		Corner Mount
PMAX-0503		Pole Mount (for PMAx-0102, PMAx-0312, PMAx-0313, PMAx-0314, PMAx-0702, PMAx-1106, PMAx-1107), supports 5.25" to 8.5" Poles
PMAX-0505		Pole Mount (for B4x, B41x, E44, E45, E46, E48, E44A, E45A, E46A, E41x, I4x, PMAx-0312, PMAx-0313, PMAx-0314, PMAx-0330), supports 2" to 3" Poles
PMAX-0511		Pole Mount (for A8x), supports 5.25" to 8.5" Poles
PMAX-0702		Junction Box for PTZ and Dome Cameras
PMAX-0704		Junction Box (for A4x, B4x, B41x, E44, E45, E46, E48, E44A, E45A, E46A, E41x, I4x, PMAx-0203~PMAx-0205)
PMAX-0807		Gangbox Converter (for PMAx-0102, PMAx-0312, PMAx-0313, PMAx-0314, PMAx-0321), supports Two-Gang Boxes
PMAX-0808		Converter Ring, 1.5" NPT for Third-Party Mounting Accessories
PMAX-0810		Mount Kit and Converter Ring, 1.5" NPT for Third-Party Mounting Accessories (for A8x, except A88)

PMAX-0813



Gang Box Converter (for A8x, except A88), supports Two-Gang Boxes

PMAX-1027



Flush Mount (for A61, A62, A8x, except A88)

**Note:** Some mounting accessories may need additional accessories for installation. Please check [www.acti.com/mountingselector](http://www.acti.com/mountingselector) for more information.

### Dome Covers - Transparent Dome Cover

R701-70009



Transparent Dome Cover (for A8x-10A)

### Power Supply Accessories - PoE Injector

PPOE-0001



PoE Injector IEEE 802.3af compliant, AC 100~240V, with universal connectors

### Audio Devices - Microphone

PMIC-0100



Active Microphone Omnidirectional for all Cameras with Line-in Audio

PMIC-0201



Passive Microphone Omnidirectional for all Cameras with Mic-In Audio using Cable Wire or Terminal Connector, 2m cable

### Other Accessories - Camera Part

R707-90004



DIO / AIO connector for A82