

GV-EBDP5800 AI 180° Panoramic 5MP H.265 Super Low Lux WDR Pro IR Eyeball Dome IP Camera



- AI deep learning: AI Perimeter Protection & Classification (Human, Vehicle)
- 1/2.7" progressive scan CMOS
- Min. illumination at 0.01 lux
- Triple streams from H.265, H.264 or MJPEG
- Up to 30 fps at 2880 x 1620
- Intelligent IR
- IR distance up to 20 m (65 ft)
- Day and night function (with removable IR-cut filter)
- 180° panoramic view
- Ingress protection (IP67)
- Vandal resistance (IK10 for metal casing)
- DC 12V / PoE (IEEE 802.3af)
- Built-in microSD card slot (SD / SDHC / SDXC) for local storage
- Built-in Microphone
- Wide Dynamic Range Pro (WDR Pro)
- AI analytics (Intrusion, Crossing Line, Entering Area, Leaving Area)
- 3D noise reduction
- Motion detection
- Tampering Alarm
- Defog
- Text overlay
- Privacy mask
- 12 languages supported
- ONVIF (Profile G, S, T, M) conformant

Introduction

The panoramic eyeball IP camera is an outdoor, network camera that captures 180° horizontal coverage, providing a wide coverage of view for open and large areas with just one camera. It is equipped with an automatic IR-cut filter and IR LEDs for day and night surveillance. GV-EBDP5800 adheres to IK10 and IP67 standards, and can be powered through PoE. The camera supports H.265 video codec to achieve better compression ratio while maintaining high quality pictures at reduced network bandwidths.

Empowered by deep learning algorithms, AI technology distinguishes human and vehicles from other moving objects. Integrated with GeoVision Video Management Software (VMS), it supports AI perimeter protection, real time alert, event playback and more.

180 Degree Panoramic View



Deep Learning Function

AI Perimeter Protection

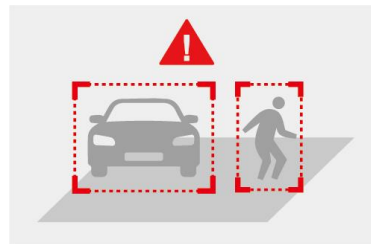

(Intrusion, Crossing Line Entering Area, Leaving Area)

Dimensions

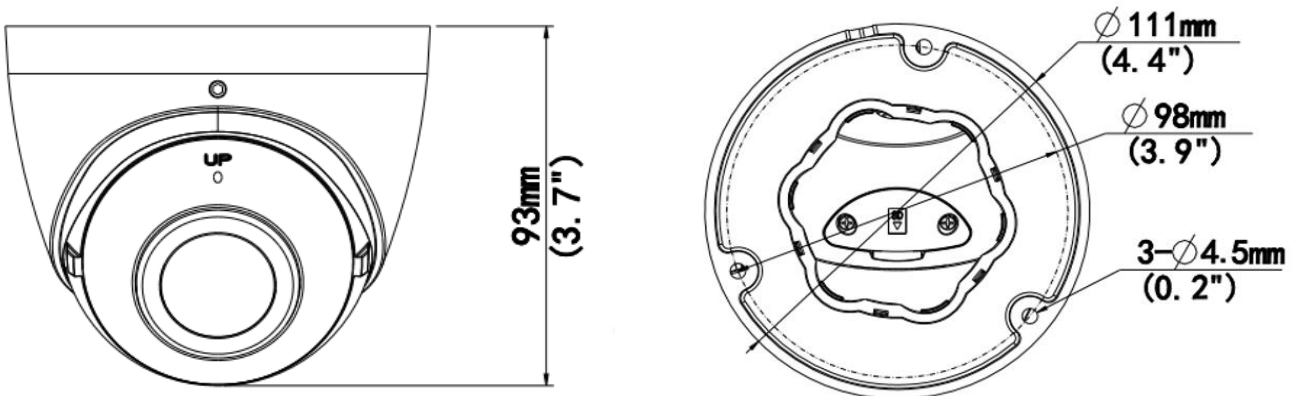

Specifications

Camera		
Image Sensor		1/2.7" progressive scan CMOS
Picture Elements		2880 (H) x 1620 (V)
Minimum Illumination	Color	0.01 Lux (F2.0, AGC ON)
	IR On	0 Lux
Shutter Speed		Auto / Manual (1 ~ 1/100000 sec)
White Balance		Auto / Manual

Gain Control	Auto / Manual			
S/N Ratio	56 dB			
WDR Pro	Yes			
Dynamic Range	120 dB			
Lens				
Megapixel	5 MP			
Day/Night	Yes (with removable IR-cut filter)			
Focal Length	1.68 mm			
Lens Type	Fixed			
Maximum Aperture	F/2.0			
Mount	Ø12 mm			
FOV	Horizontal	180°		
	Vertical	100°		
	Diagonal	180°		
Operation	Focus	Fixed		
	Zoom	Fixed		
	Iris	Fixed		
IR LED Quantity	2 IR LEDs			
Max. IR Distance	20 m (65 ft)			
DORI	Detect	Observe	Recognize	Identify
Lens	1.68 mm	37.8 m (124.0 ft)	15.1 m (49.6 ft)	7.6 m (24.8 ft)
Operation				
Video Compression	H.265, H.264, MJPEG			
Video Streaming	Triple streams			
Video Resolution	Main Stream	2880 x 1620 (Default), 2560 x 1440, 2304 x 1296, 1920 x 1080		
	Sub Stream	1920 x 1080, 1280 x 720, 720 x 576, 640 x 480, 640 x 360 (Default), 704 x 288, 352 x 288		
	Third Stream (Closed by Default)	720 x 576, 704 x 288, 640 x 360, 352 x 288		
Frame Rate	30 fps at 2880 x 1620, 2560 x 1440, 2304 x 1296, 1920 x 1080 (50/60 Hz) *The frame rate and performance may vary depending on the number of connections and data bitrates (different scenes).			
Maximum throughput	40 Mbps			
Maximum stream *When the total bitrate is within the maximum throughput	20			
Video Analytics	Motion Detection, Audio Alarm, Tamper Detection. *Tampering detection and audio alarm are only accessible through the camera's Web interface, which can be used to trigger alerts such as e-mail and FTP			
Image Setting	Brightness, Contrast, Saturation, Sharpness, Flicker-less, 3D Noise Reduction, Image Orientation (Flip, Mirror, 0°, 180°)			
Audio Compression	G.711			
Audio Support	One-way Audio			
Deep Learning Function				
AI Analytics	Human & Vehicle classification: Intrusion, Crossing Line, Entering Area, Leaving Area			
Network				
Interface	10/100 Ethernet			
Protocol	802.1X (including EAP-TLS), ARP, DDNS, DHCP, DNS, FTP, HTTP, HTTPS, IGMP, IPv4, IPv6, NTP, ONVIF (Profile G, S, T, M), PPPoE, RTCP, RTP, RTSP, SMTP, SNMP, TCP, UDP			
Mechanical				
Camera Angle Adjustment	Pan	0° ~ 360°		
	Tilt	0° ~ 75°		
	Rotate	0° ~ 360°		
Connectors	Power	DC Jack, PoE		
	Ethernet	RJ-45		
	Audio	1 In (built-in microphone)		

	Local Storage	microSD card slot (SD / SDHC / SDXC), up to 512 GB
General		
Operating Temperature	-30°C ~ 60°C (-22°F ~ 140°F)	
Humidity	0 ~ 95% (no condensation)	
Power Source	1.25A 12V DC / PoE (IEEE802.3af)	
Max. Power Consumption	5.5 W	
Dimensions	Ø 111 x 93 mm (Ø 4.4" x 3.7")	
Weight	0.48 kg (1.06 lb)	
Ingress Protection	IP67	
Vandal Resistance	IK10 for metal casing	
Certification	CE, FCC, LVD, RoHS, UL compliant	
Web Interface		
Installation Management	Web-based configuration	
Maintenance	Firmware upgrade through Web Browser or Utility	
Access from Web Browser	Live View, Video Recording, Change Video Quality, Bandwidth Control, Image Snapshot, Text Overlay, Image Masking	
Language	Czech, English, French, German, Hungarian, Italian, Japanese, Polish, Portuguese, Russian, Spanish, Traditional Chinese	
Software Applications		
Software Supported	GV-VMS (V17.4.7 with patch / V18.3.2 with patch or later), GV-Control Center (V3.8.0 with patch / V4.2.0 or later), GV-Edge Recording Manager Windows Version (V2.2.7 or later), GV-Recording Server / Video Gateway (V2.1.0 or later)	
Smart Device Access	GV-Eye for iOS / Android (V3.1.0 / V3.1.1 or later)	
Live Viewing	Browser (IE, Edge, Chrome, Firefox)	

Note: Specifications are subject to change without notice.

Packing List





- | | |
|--------------------------------|--------------------------|
| 1. GV-EBDP5800 IR Eyeball Dome | 4. Drill Template Paster |
| 2. Waterproof Rubber Set | 5. Torx Wrench |
| 3. Screw kit | 6. Download Guide |

Accessories

Model No.	Name		Details
GV-Mount107 (must be used with GV-Mount213)	Pendant Bracket		Dimensions: Ø 120 x 334 mm (Ø 4.72" x 13.15") Weight: 0.74 kg (1.63 lb)
GV-Mount211P	Wall Mount and Junction Box		Dimensions: Ø 233 x 126 x 126 mm (Ø 9.2" x 5" x 5") Weight: 1 kg (2.2 lb)
GV-Mount211-1	Wall Mount and Junction Box		Dimensions: 235 x 126.2 x 128.5 mm (9.3" x 5.0" x 5.1") Weight: 0.84 kg (1.85 lb)
GV-Mount213	Wall / Ceiling Box Mount		Dimensions: Ø 109 x 39 mm (Ø 4.3" x 1.5") Weight: 0.2 kg (0.44 lb)

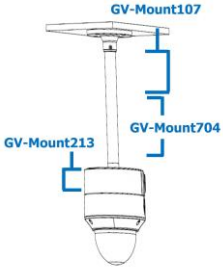
<p>GV-Mount300-2 (must be used with GV-Mount211P, GV-Mount211-1, or GV-Mount213)</p>	<p>Convex Corner Mount</p>		<p>Dimensions: 137 x 233 x 160 mm (5.4" x 9.17" x 6.3") Weight: 1.65 kg (3.64 lb)</p>
<p>GV-Mount310-2 (must be used with GV-Mount211P, GV-Mount211-1, or GV-Mount213)</p>	<p>Concave Corner Mount</p>		<p>Dimensions: 111.2 x 369.9 x 210 mm (2.6" x 11.4" x 6.6") Weight: 1.65 kg (3.64 lb)</p>
<p>GV-Mount420 (must be used with GV-Mount211P)</p>	<p>Pole Mount Bracket</p>		<p>Dimensions: \varnothing 120 x 120 x 53.4 mm (\varnothing 4.7" x 4.7" x 2.1") Weight: 0.45 kg (0.99 lb) Steel Strap Diameter: \varnothing 67 ~ 127 mm (\varnothing 2.6" ~ 5")</p>
<p>GV-Mount440-1 (must be used with GV-Mount211P or GV-Mount211-1)</p>	<p>Pole Mount Bracket</p>		<p>Dimensions: 136 x 127 x 63.6 mm (5.4" x 5.0" x 2.5") Weight: 0.34 kg (0.75 lb) Steel Strap Diameter: \varnothing 67 ~ 127 mm (\varnothing 2.6" ~ 5")</p>
<p>GV-Mount704 (must be used with GV-Mount107)</p>	<p>Extension Tube</p>		<p>Dimensions: \varnothing 3.5 x 10 or 20 or 30 or 50 cm (\varnothing 1.38 x 3.9 or 7.9 or 11.8 or 19.7") Weight: 225g or 360g or 500g or 780g (0.5 lb or 0.79 lb or 1.1 lb or 1.72 lb)</p>
<p>GV-Mount924 (for standard US single and double gang boxes only)</p>	<p>Power Box Mount Bracket</p>		<p>Dimensions: \varnothing 128 x 18.5 mm (\varnothing 5" x 0.7") Weight: 0.15 kg (0.33 lb)</p>
<p>GV-PA191</p>			<p>GV-PA191 is a Power over Ethernet (PoE) adapter designed to provide power to the IP device through a single Ethernet cable.</p>
<p>GV-PA301</p>			<p>GV-PA301 is a Gigabit Power over Ethernet (PoE) adapter designed to provide power to the IP device through a single Ethernet cable.</p>
<p>GV-POE Switch</p>	<p>The GV-POE Switch is designed to provide power along with network connection for IP devices. The GV-POE Switch is available in various models with different numbers and types of ports.</p>		
<p>Power Adapter</p>	<p>Contact our sales representatives for the countries and areas supported.</p>		

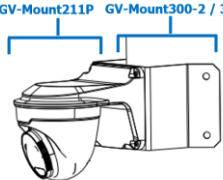
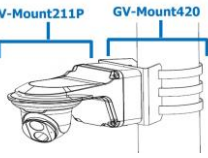
Mounting Type

Pendant Mount		Wall Mount with Junction Box	Convex / Concave Corner Mount	
GV-Mount107 + GV-Mount213	GV-Mount107 + GV-Mount213 + GV-Mount704	GV-Mount211P	GV-Mount211P + GV-Mount300-2	GV-Mount211P + GV-Mount310-2
				
Pole Mount	Wall / Ceiling Box Mount	Power Box Mount		
GV-Mount211P + GV-Mount420	GV-Mount213	GV-Mount924		
				

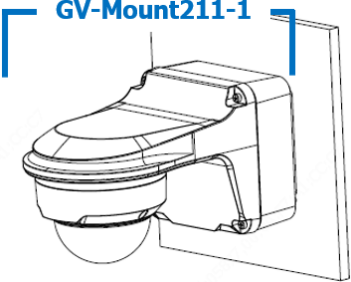
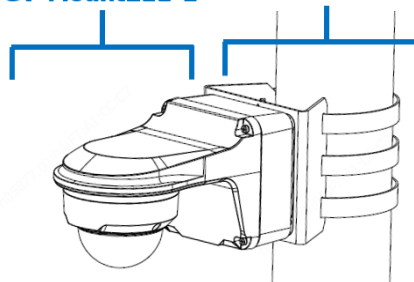
Wall Mount with Junction Box	Pole Mount
GV-Mount211-1	GV-Mount211-1 + GV-Mount440-1
	

Convex / Concave Corner Mount	Convex / Concave Corner Mount
GV-Mount211P / 211-1 + GV-Mount300-2 / 310-2	GV-Mount213 + GV-Mount300-2 / 310-2
