

# Blackjack® P-RACK

Servers Powered by DW Spectrum® IPVMS

State of the art hyper-optimized video management platform designed for ease, speed and efficiency.

Blackjack® P-Rack™ — Up to 600Mbps.

Linux OS			Windows OS		
DW-BJP1U-LX	DW-BJP2U-LX	DW-BJPR2U-LX	DW-BJP1U	DW-BJP2U	DW-BJPR2U



DW-BJP1U-LX  
DW-BJP1U



DW-BJP2U-LX  
DW-BJP2U  
DW-BJPR2U-LX  
DW-BJPR2U



Default Login Information for DW Spectrum® IPVMS

Username: <b>admin</b>	Password: <b>admin12345</b>
------------------------	-----------------------------

Default login information for the server's OS

Username: <b>dwuser</b>	Password: <b>Dw5pectrum</b>
-------------------------	-----------------------------

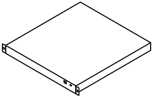
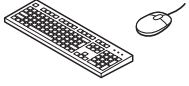
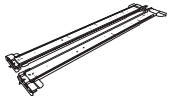
## WHAT'S IN THE BOX

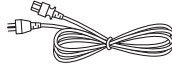
P-Rack™ server		1	Keyboard and mouse		1 set	Rail kit		1 set
Quick start guide		1	Power cable		1 set			

**NOTE:** Download all your support materials and tools in one place.

1. Go to: <http://www.digital-watchdog.com/support-download/>.
2. Search your product by entering the part number in the 'Search by Product' search bar. Results for applicable part numbers will populate automatically based on the part number you enter.
3. Click 'Search'. All supported materials, including manuals, Quick Start Guides (QSG), software and firmware will appear in the results.



**Attention:** This document is intended to serve as a quick reference for initial setup. See the DW Spectrum® IPVMS full manual for more information on features and functionality.

# Blackjack® P-RACK

Servers Powered by DW Spectrum® IPVMS

## BLACKJACK® P-RACK™ HARDWARE

Front 1U models

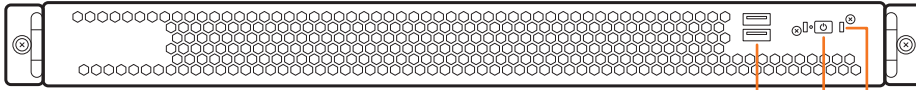

F1 F2 F3

Front 2U models

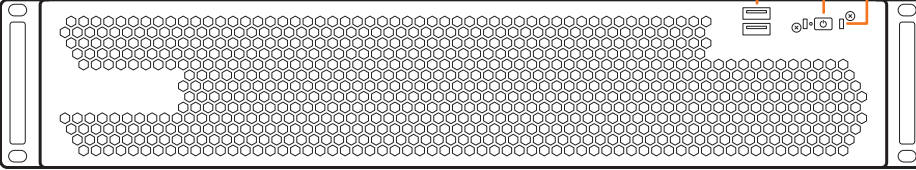

- F1 2x USB 2.0 ports
- F2 Power button
- F3 HDD status LED

Back 1U models



B7 B12 B13

Back 2U models

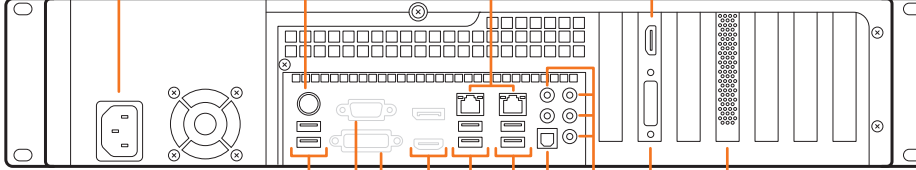

B1 B2 B3 B4 B5 B6 B7 B8 B9 B10 B11 B12 B13

- B1 Power output
- B2 Keyboard port (PS2 type)
- B3 USB 2.0 ports
- B4 VGA output (disabled)
- B5 DVI-D output (disabled)
- B6 True HD output (disabled)
- B7 Network ports
- B8 USB 3.0 ports
- B9 Optical digital audio output
- B10 Audio ports
- B11 RAID\* (DW-BPR2U models only)
- B12 DVI-I output
- B13 True HD output

Default login information for DW Spectrum® IPVMS

Username: <b>admin</b>	Password: <b>admin12345</b>
------------------------	-----------------------------

Default Login Information for the server's OS

Username: <b>dwuser</b>	Password: <b>Dw5pectrum</b>
-------------------------	-----------------------------

## SPECIFICATIONS

MODEL	Blackjack P-Rack 1U	Blackjack P-Rack 2U	Blackjack P-Rack 2U w/RAID	
Included IP licenses	4	4	4	
Form factor	Rack-mount	Rack-mount	Rack-mount	
Operating system	Windows® 10 IoT	DW-BJP1UXT	DW-BJP2UXT	DW-BJPR2UXXT
	Linux® Ubuntu® 18.04 LTS	DW-BJP1UXT-LX	DW-BJP2UXT-LX	DW-BJPR2UXXT-LX
	OS on SSD	Yes	Yes	Yes Option: DW-SSD64 - spare SSD for mirroring OS *
CPU	Intel® Core™ i5® processor		Intel® Core™ i7® processor	
	Option: DW-CPUi7 - upgrade processor to i7 *			
Memory	8GB		16GB	
	Option: DW-RME8 - upgrade memory to 16GB *			
NIC	2x gigabit Ethernet (RJ45)		2x gigabit Ethernet (RJ45) Option: DW-R2NIC - upgrade dual 1GB NIC card OR DW-R4NIC - upgrade quad 1GB NIC card *	
System	Max video storage rate (Mbps)	360 Mbps	600 Mbps	
	Maximum hard drives	3 x HDD	6 x HDD	6 x HDD
Storage	Maximum storage	48TB	112TB	112TB raw storage (80TB usable storage, RAID 5)
	Outputs	True HD output or VGA or DVI		
Video-out	Video card	GeForce 210 512MB		
	Resolution	Option: DW-RV4H - 4 head HD video card* HD 1080p		
	Preloaded VMS software	DW Spectrum® IPVMS		
Unlimited remote clients	Cross platform - Windows®, Linux® and Mac®			
Mobile apps	iOS® and Android®			
Keyboard and mouse	Included			
Rail-kit	Included			
Power	300W**		400W**	
Operating temperature and humidity	41°F-104°F / 20-90% RH			
Dimension (WxDxH)	17.25" x 20.85" x 1.75"	17.32" x 26" x 3.5"	17.32" x 26" x 19"	
Warranty	5 year limited			

\* Available at time of initial order only / \*\* UPS recommended  
Specifications and components mentioned are subject to change without notice.

## SETTING UP THE SERVER

### STEP 1: Connect external devices, power and network.

1. Connect a monitor, USB keyboard, USB mouse and network cable to one of the Ethernet ports (B7 on the diagram). Configure the camera's network first, then configure the server's local network.
2. Connect the server to an appropriate power source. It is recommended to use a UPS system.  
\* Recommended to use 750VA or higher for the 1U P-RACK and 1000VA or higher for the 2U P-RACK
3. Power up the server if the server does not turn on automatically by pressing the power button on the front of the server. (F2 on the diagram).  
\* Connecting the power cable to the live power source may turn on the server automatically.

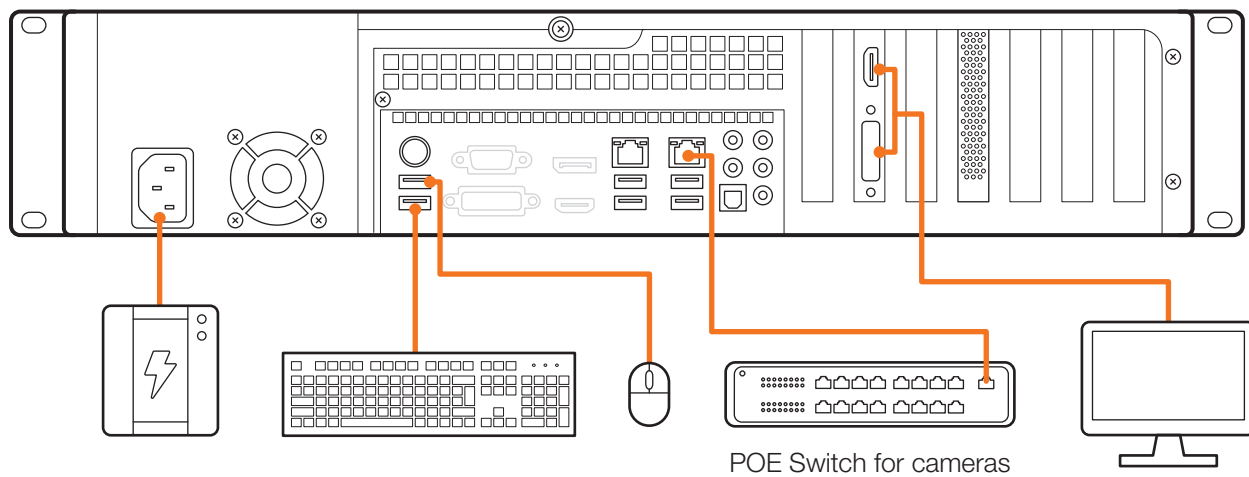
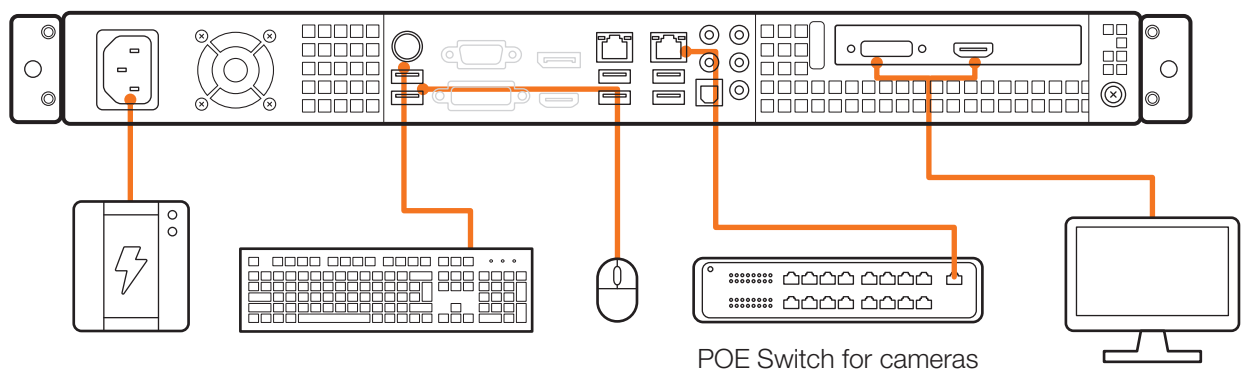

### STEP 2: Configure date and time Windows®

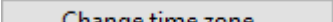
1. Double-click on the date and time icon on the desktop.
2. Change time zone if it is not correct  (default is UTC-08:00 Pacific Time).





Press OK after selecting the correct time zone.

Click “Change date and time...” to update the date and time if they are not correct.

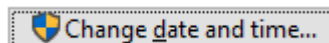

\* Verify the time zone before updating the date and time. Time may show 2 or 3 hours off due to incorrect time zone.

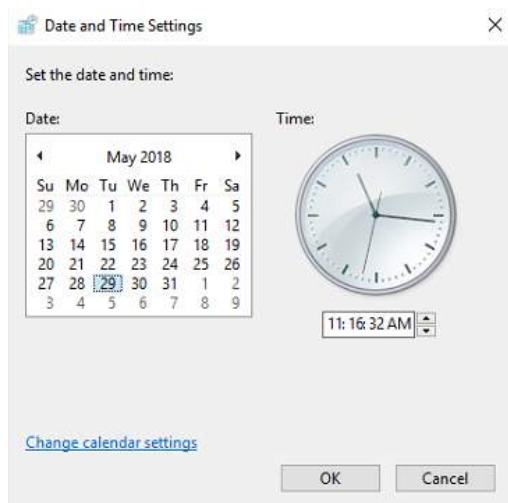

Press OK after adjusting to the correct date and/or time.

4. Press OK to close the date and time when done.

## Linux®

1. Open Settings

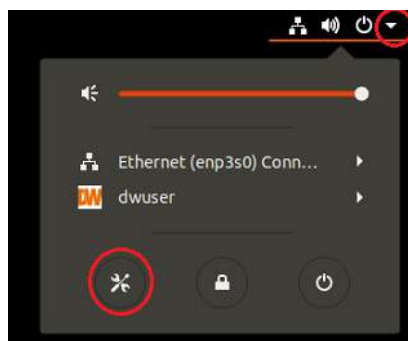

## 2. Click Details

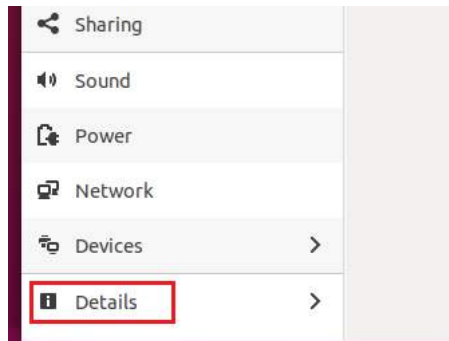

## 3. Click Date & Time

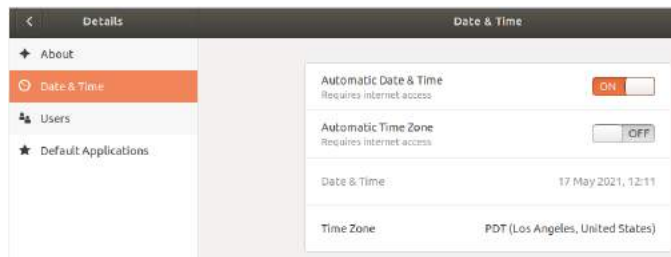

## 4. Turn OFF Automatic Date & Time and Automatic Time Zone

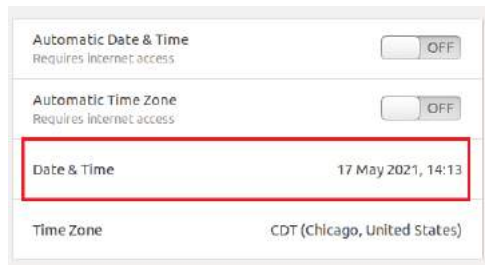

## 5. Click Date & Time and set correct date and time

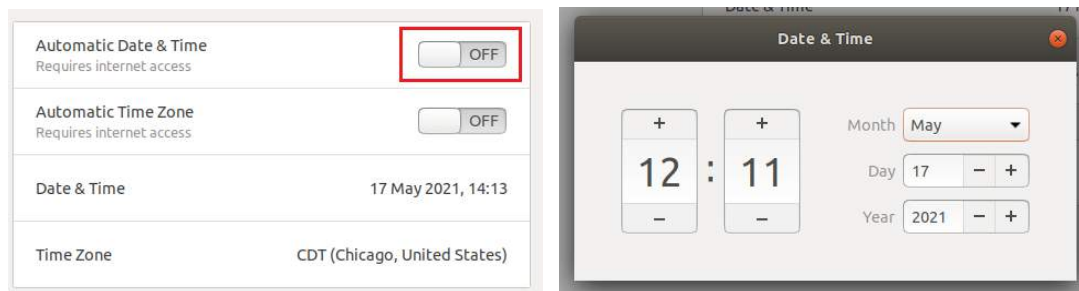

## 6. Click Time Zone and set to correct Time zone. (type one of the largest cities in the time zone)



## 7. Close Settings.

## STEP 3: Configure network

Please have the following information ready before starting the network configuration.

	Camera network	Local network (LAN)
IP address		
Subnet mask / Netmask		
Default gateway / Gateway	Not applicable	
DNS servers	Not applicable	

\* Camera network and local network cannot be on the same network.

**NOTE** The Blackjack® server's network settings are set to DHCP as default.

**NOTE** If you are not sure what information to enter, contact your Network Administrator or Internet Service Provider for the information.

### Windows®



1. Double click on "Network Connections" on the desktop.
2. Right click on the Ethernet with cable connected and click "Properties".



3. Select "Internet Protocol Version 4 (TCP/IPv4)" and click "Properties".

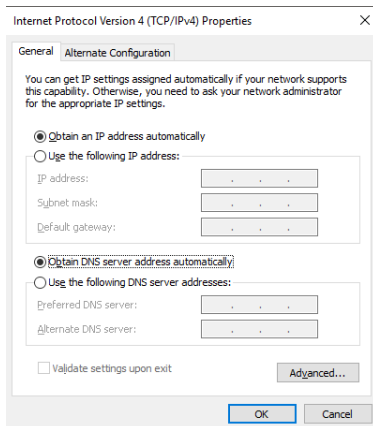
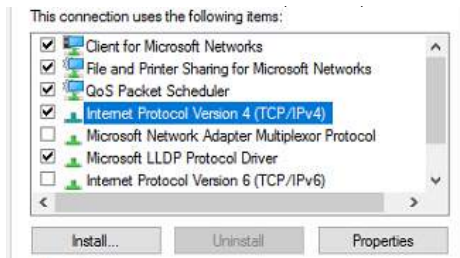

4. Select “Use the following IP address” (Use the following DNS server addresses will be selected automatically).
5. Enter IP address and Subnet mask of the camera network. (Do not enter anything for the default gateway, preferred DNS server and alternate DNS server).

**NOTE** It must be the same network as the cameras and must not be the same network as the local network. Contact your network administrator for more information.

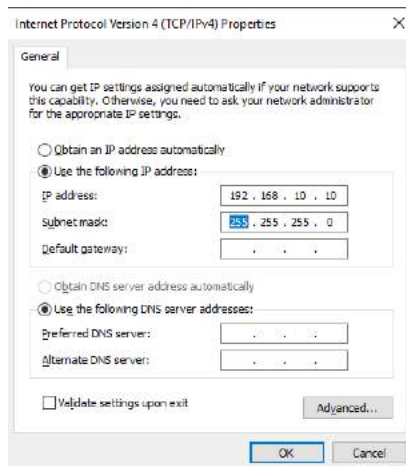

6. Click OK to close then click close to go back to network connections.

## Local Network

7. Right-click on the other Ethernet, the one with network cable unplugged, and click “Properties”.
8. Select “Internet Protocol Version 4 (TCP/IPv4)” and click “Properties”.

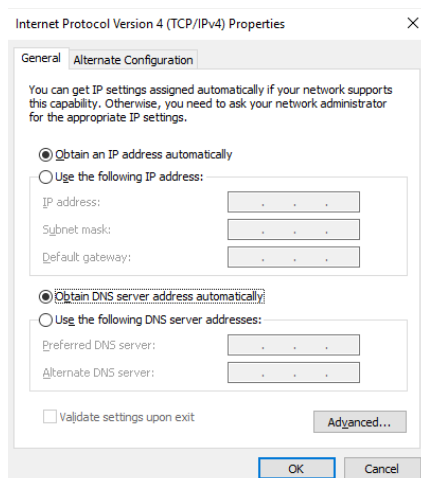
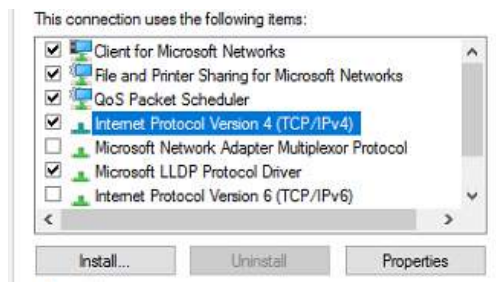

9. Select “Use the following IP address” (Use the following DNS server addresses will be selected automatically).
10. Enter IP address and subnet mask of the camera network.

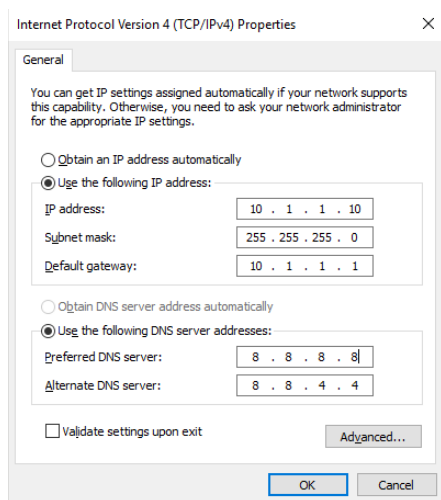

11. Click OK to close then click close to go back to network connections.
12. Connect a network cable to the Ethernet port B7 on the diagram (page 2) to the switch on the local network.
13. Close the network connections dialog.

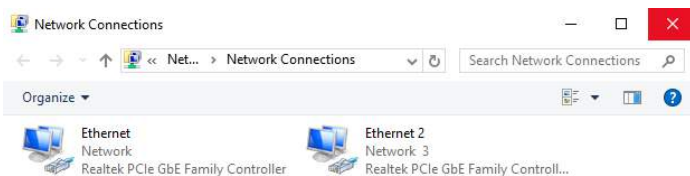

## Linux®

1. Open Settings

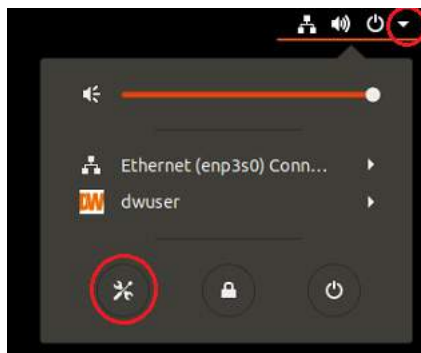

2. Open Network





3. Click Setting of the Ethernet that is Connected

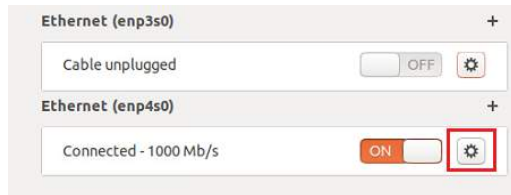

4. Change to Manual then enter Address, Netmask , Gateway.

\* Do not enter Gateway information if there is no Gateway in this network.



5. Click Apply to save



6. Restart the connection by switching OFF then turn ON.



7. Click Settings of the Ethernet not connected.

8. Change to Manual then enter Address, Netmask, Gateway then DNS.

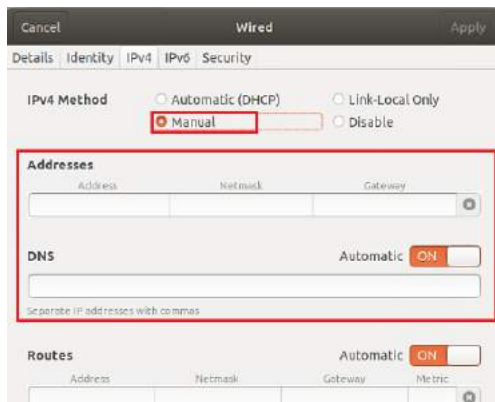

9. Click Apply to save



10. Connect the network cable and verify the connection.

**NOTE** If you are not connecting to the Blackjack® from the same network, you may be required to perform port forwarding on your router to access the server. Contact your Network Administrator or Installer for additional information

## CONFIGURE CAMERAS USING DW<sup>®</sup> IP FINDER<sup>™</sup>

Refer to the camera's QSG to configure any DW<sup>®</sup> IP camera's IP address using DW<sup>®</sup> IP finder<sup>™</sup>.

### DW Spectrum<sup>®</sup> IPVMS client



Linux OS

#### LINUX-BASED SOFTWARE MANUAL LAUNCH

To launch the DW Spectrum<sup>®</sup> software on the Linux-based E-RACK

OPTION 1: Double-click the DW Spectrum<sup>®</sup> desktop icon.



OR

OPTION 2: Go to the dashboard on the top left side. Search 'DW'. Click the DW icon.

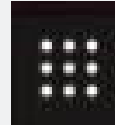

Windows

#### WINDOWS-BASED SOFTWARE MANUAL LAUNCH

To launch the DW Spectrum<sup>®</sup> software on the Windows-based E-RACK:

OPTION 1: Double-click the DW Spectrum<sup>®</sup> desktop icon.



OR

OPTION 2: Go to 'Start' on the bottom left and select DW Spectrum<sup>®</sup> in the Digital Watchdog folder

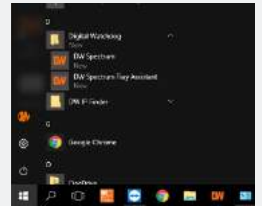

## SETTING UP DW SPECTRUM<sup>®</sup> MEDIA SERVER

Login: **admin**  
Password: **admin12345**

## STEP 1: Initial run from the Blackjack® server

1. Open the DW Spectrum® client by double click on the DW Spectrum® icon.
2. Click on the pre-configured server.



3. Enter the password and click connect.  
\* Default password: admin12345 (case sensitive).



## STEP 2: To rename the server

1. Right-click on the server name listed on the resources then click server settings.

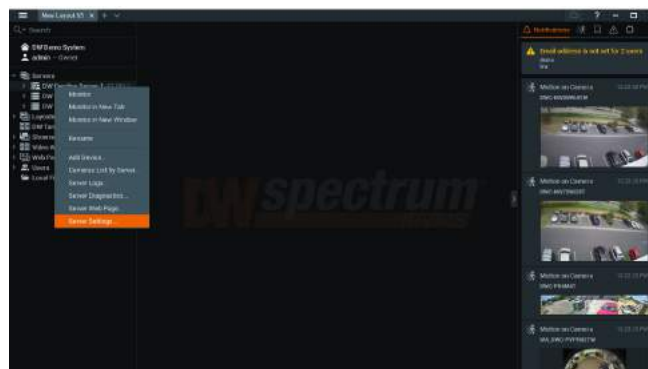

2. Go to the general tab and enter the new server name in the name field. Click OK.

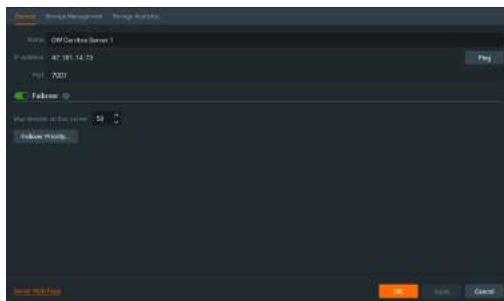

### STEP 3: To check for updates

1. Click on the menu  then click "System Administration".

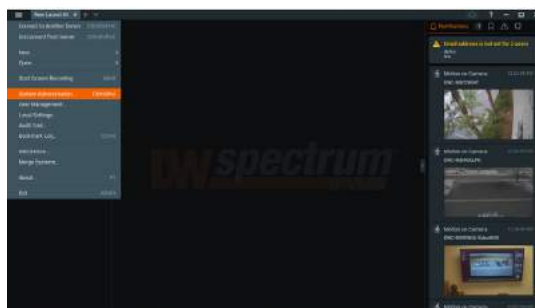

2. Go to the updates tab. If the system requires updating, click on the update system button.

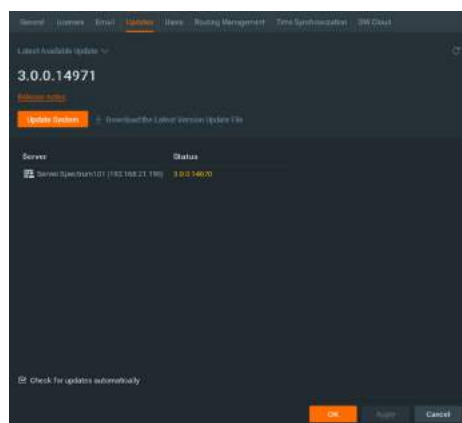

\* If you are on the latest version, it will say "You have the latest version installed" and the Update System button will be disabled.

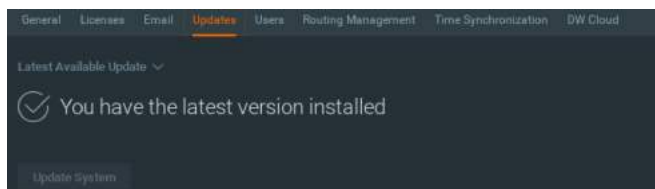

3. Click OK when the update is completed.

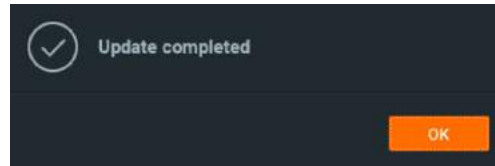

## STEP 4: Enter and activate licenses

1. Go to the system administration window and click on the license tab.
2. Enter the license key and click "Activate License". An Internet connection is required.  
\* Click on "Activate Trial License" if you have not purchased a valid license key.

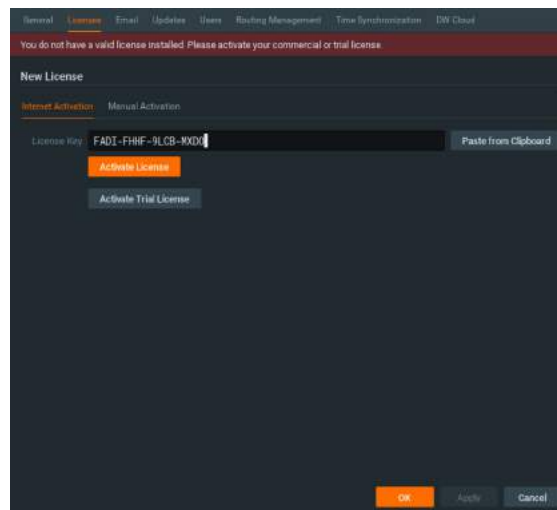

3. Click OK to when the license key is activated.

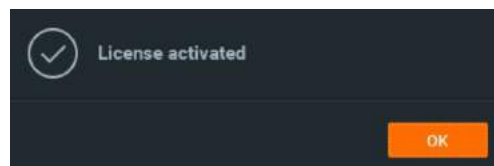

## STEP 5: Configure recording

1. Right-click on a camera in the resource tree to setup recording. Click on camera settings from the context menu.

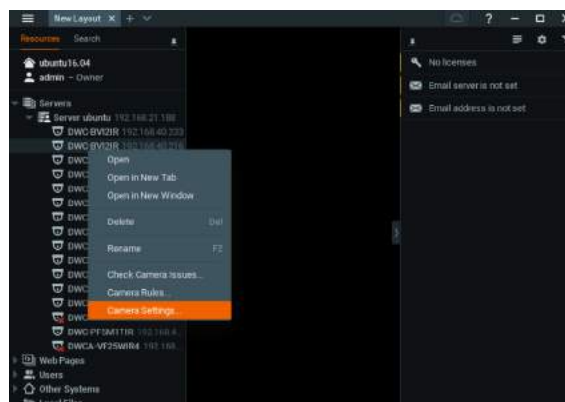

2. Go to the recordings tab.

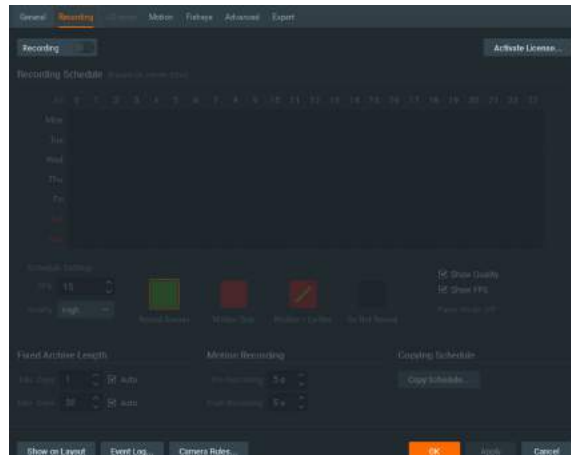

3. Click  to turn on recording.

4. Configure the camera's schedule settings for quality, FPS and recording type.

5. Click and drag the mouse over the recording schedule to apply the settings to multiple days and times.

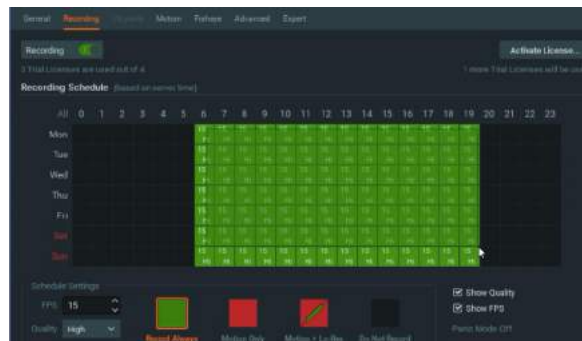

\* Click "All" to apply the recording settings to the entire schedule.

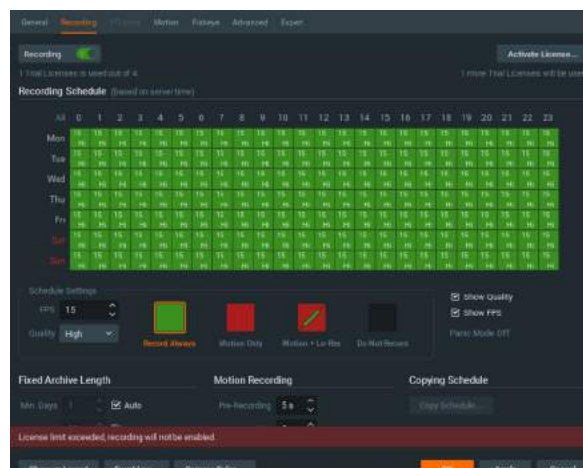
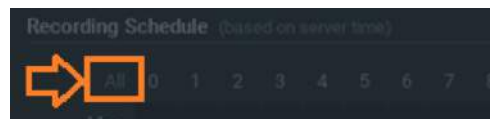

- A red dot will appear next to the camera in the resource tree once recording is started.

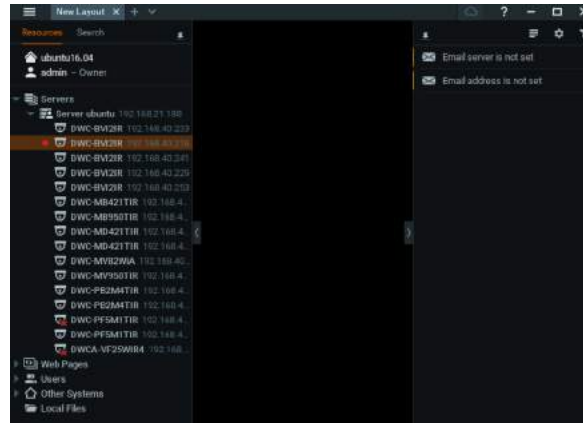

## STEP 6: Backup database

- Go to the system administration window and click on the general tab.

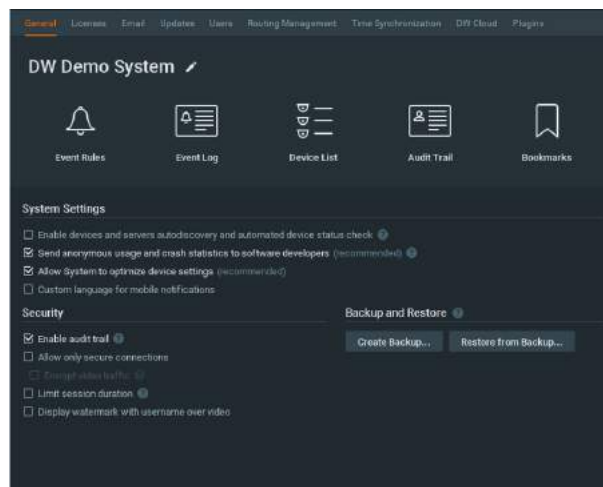

- Click "Create Backup...".
  - Navigate to the folder you want to save the database and enter a name for the backup file. Click save.
- \* It is strongly recommend to backup your data to an external storage media as well.

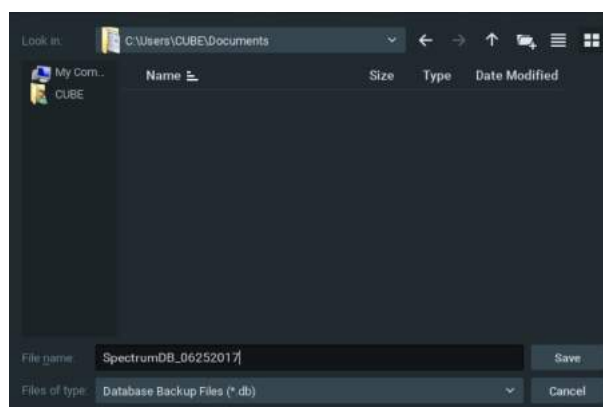

**NOTE:** More information and instructions are available in the DW Spectrum® IPVMS user manual.

# TROUBLESHOOTING TIPS

Problem	Possible solutions
My camera does not auto-discover	<ol style="list-style-type: none"> <li>1. Is the camera in the same LAN network as the media server?</li> <li>2. Is your camera compatible with DW Spectrum®? (Refer to our website for full list of supported cameras.)</li> <li>3. Is the camera updated to its latest firmware?</li> <li>4. If your camera is integrated with DW Spectrum® via ONVIF, make sure ONVIF is enabled on your camera.</li> <li>5. Try adding the camera manually.</li> <li>6. Try rebooting the server after installation. Allow up to 2 minutes for the server to map your network and detect all supported devices.</li> </ol>
Videos are slow	<ol style="list-style-type: none"> <li>1. Are you accessing the same cameras from multiple clients? (LAN and WAN)</li> <li>2. Do you have a Gigabit network? Check your network speed.</li> </ol>
My camera appears disconnected	<ol style="list-style-type: none"> <li>1. Under camera settings, make sure the user name and password are correct.</li> <li>2. Under the camera settings, use the 'Ping' button to make sure the camera is connected to the network properly.</li> <li>3. If you can connect to the camera's web viewer, try rebooting the camera and/or restore it to factory default.</li> <li>4. Make sure your camera is using the latest firmware available.</li> <li>5. Make sure that the camera is connected to the same network as the server.</li> <li>6. If you are connecting to a camera that is integrated with DW Spectrum® via the ONVIF protocol (see list), make sure ONVIF is enabled.</li> <li>7. Make sure your user has permissions to view that specific camera.</li> </ol>
I cannot get playback video from my camera	<ol style="list-style-type: none"> <li>1. Do you have network connection between client and server (in case server and client are not on the same machine)?</li> <li>2. Make sure your user has playback viewing permissions for the selected channel.</li> <li>3. Make sure the camera is set to a recording mode that would provide recorded video for the selected time and environment.</li> <li>4. On the server side, check the media server log to make sure the camera you are trying to watch has not been unexpectedly disconnected.</li> </ol>
I get an 'unauthorized' message on my camera	<ol style="list-style-type: none"> <li>1. Make sure the camera's user name and password are properly entered in the camera's general information under the camera settings menu.</li> <li>2. If necessary, try rebooting the camera to apply the camera's user name and password.</li> </ol>

## DW SPECTRUM SYSTEM REQUIREMENTS

### Recommended specs for the full client

	Single-monitor DW Spectrum workstation	Dual-monitor DW Spectrum workstation	Quad-monitor DW Spectrum workstation
Processor	Intel i5 8th gen or AMD Ryzen 5 3000 Quad-Core or better	Intel i7 8th gen or AMD Ryzen 7 3000 Quad-Core or better	Intel i9 or AMD Ryzen 9 Quad-Core or better
Video card	Intel HD Graphics onboard GPU or better	Intel HD Graphics onboard GPU or better	GeForce GTX 1650 or better
RAM	8 GB DDR3 1600 MHz or better	16 GB DDR3 1600 MHz or better	32 GB or better
NIC	1Gbps or better	2 x 1 Gbit or better	2 x 1 Gbit or better
Storage	Dedicated SSD or NVME disk for the OS, 128 GB or larger	Dedicated SSD or NVME disk for the OS, 128 GB or larger	Dedicated SSD or NVME disk for the OS, 128 GB or larger
OS supported	Microsoft Windows OS <ul style="list-style-type: none"> <li>• Windows 8 - Released: October 2012   EoS: 01/2023</li> <li>• Windows 8.1 - Released: October 2013   EoS: 01/2023</li> <li>• Windows 10 - Released: July 2015</li> <li>• Windows Server 2012 - Released: August 2012   EoS: 10/2023</li> <li>• Windows Server 2012 R2 - Released: October 2013   EoS: 10/2023</li> <li>• Windows Server 2016 - Released: October 2016   EoS: 01/2027</li> <li>• Windows Server 2019 - Released: October 2018   EoS: 01/2029</li> </ul>		
	Ubuntu (Debian-based Linux) OS <ul style="list-style-type: none"> <li>• Ubuntu 16.04 LTS "Xenial Xerus" - Released: April 2016   EoS: 04/2024</li> <li>• Ubuntu 18.04 LTS "Bionic Beaver" - Released: April 2018   EoS: 04/2028</li> </ul>		
	Macintosh OS <ul style="list-style-type: none"> <li>• macOS 10.14 "Mojave" - Released: September 2018</li> <li>• macOS 10.15 "Catalina" - Released: October 2019</li> <li>• macOS 11.0, 11.1, 11.2 "Big Sur" - Released: November 2020</li> </ul>		
**NOTE: DW Spectrum IPVMS for macOS is only supported by the DW Spectrum Client.			

\* Except Storage Server version

Important: OS not listed will not be supported by DW® Tech Support

Tel: +1 (866) 446-3595  
Fax: (813) 888-9262



www.digital-watchdog.com  
sales@digital-watchdog.com