

ConteraCMR® NVR Appliance

20TB Max Storage 24 Max Channel Count Cloud Managed Recorder with 8 or 16 Port Built-in-PoE Switch and Dual NIC



Arecont Vision® ConteraCMR® NVR appliance is designed to offer powerful IP recording in an affordable, compact chassis. The ConteraCMR NVR appliance is equipped with an on-board 8 or 16 channel PoE switch, with a recording capacity of up to 24 channels, allowing for Plug and Play connection with Arecont Vision and ONVIF cameras or RTSP video streams. With full integration to ConteraWS® Web Services, the ConteraCMR NVR appliance offers centralized

user management, single sign-on convenience, mobile apps and a web client that allows for easy remote connection to your recorders. Network setup is fast and easy using ConteraWS Web Services, and eliminates the need for port forwarding or DDNS. The ConteraCMR NVR appliance runs on a secure Linux® OS and comes preloaded with ConteraVMS® Server software as a turn key solution.

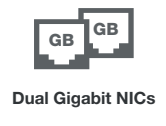

Centralized User Management

ConteraWS provides secure storage of all user profile information, allowing role-based management for hundreds of users and device permissions.



Health Monitoring

Cloud-based health monitoring ensures your cameras and recorders are working properly and minimum recording retention levels are being met.



Alerts and Reports

ConteraWS grants insight into operational events at recorder locations and provides valuable business intelligence based on customer or employee activity.



Single Sign-on

Log into ConteraWS Web Services, ConteraVMS, and Arecont Vision Mobile using the same email address and password.

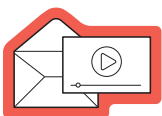

Clip Sharing

Export video clips to the cloud so they cannot be overwritten or lost. Share video clips via email with password protection.

Series Features

- Cloud Management with ConteraWS
- ConteraVMS Ready
- Cloud Video Export and Sharing
- 2, 4, 6, 8, 12, 16, or 20TB Storage Capacity
- 2 Hard Disk Drives (HDDs)
- Linux OS
- Built-in PoE Switch
- 8 or 16 PoE Channels
- 24 Max Channel Count¹
- IP Channel Upgrades
- Solid State OS Drive (SSD)
- Intel® Celeron® Processor
- Dual Gigabit NICs
- 1U Rack Mountable
- 3-Year Hardware Warranty
- 1-Year Advanced Replacement

¹ 8-PoE channels + 16-non-PoE channels or 16-PoE channels + 8-non-PoE channels

Recorder Specifications

Model		AV-C800	AV-C1600
Recording	Max IP Channels	24	
	Max IPS Per Channel	30IPS (dependent on camera settings)	
	Built-in PoE Ports	8	16
	Recording Resolutions	Up to 4K (dependent on camera settings)	
	Recording Rate	Up to 100Mbps	
	Maximum Display Resolution	4K (HDMI) / 1080P (VGA)	
	Image Compression	H.264	
	Audio Support	IP camera audio (dependent on camera)	
Connections	Video Outputs	1 x HDMI / 1 x VGA	
	Alarm Sensor Inputs	4 x Form A contacts	
	Digital Relay Outputs	2 x Form A contacts	
	USB Ports	Front: 2 x USB 2.0 Rear: 2 x USB 2.0 / 2 x USB 3.0	
Software	Video Signal Loss Detection	Yes	
	Maximum Console Live View	16 Channels	
	Maximum Client Side Live View	16 Channels	
	Maximum Search	16 Channels	
	Motion Detection	Arecont Vision® camera side or ONVIF Profile S server side	
	Remote Operation	ConteraVMS® thick client / thin (web) client / mobile apps	
	User Management	Web or local based user permissions and account management	
	Recording Mode	Continuous / Motion / Continuous + Motion / Live Only	
	Playback Search	Multi-channel playback (1, 4, 9) / Calendar / Timeline / Thumbnail / Event (VMS and web client) / Object (VMS)	
	Clip Backup	Cloud / USB	
	Digital Signature Support	MP4	
	Web Connect	Yes	
Operating System	Linux®		

General

Network	Dual gigabit NICs
Keyboard and Mouse	Included
DVD Drive	N/A
PoE Switch Load	150W PoE switch load (maximum 25W per port)
Operating Temperature	Max temperature: 104°F (40°C)
OS Drive Configuration	SSD
Storage Configuration	Up to 20TB
Rack Mount	Rack mount installation kit included
Warranty	3 Years, 1 year advanced replacement
System Control	Keyboard, mouse (included)

Electrical

Input Voltage	290W (100V–240V auto switching)
Power Consumption	195W max

Compliance

IP Camera Support	Arecont Vision / ONVIF Profile S / RTSP
Certification	UL certified
CoO	Made in China

Mechanical

Dimensions <i>(See Dimensions)</i>	Unit	17.25" W (438mm) x 1.75" H (44mm) x 13.5" L (343mm)
	Packaged	20.5" W (521mm) x 6.5" H (165mm) x 19.75" L (502mm)
Weight	Unit	15lbs (6.8kg)
	Packaged	20lbs (9.1kg)

Controls and Connections

Front Panel

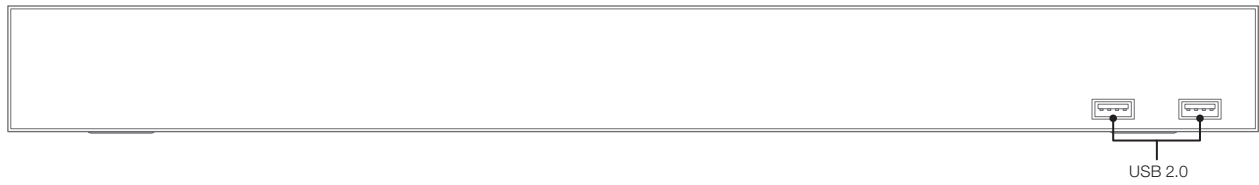

Rear Panel - 8 Channel

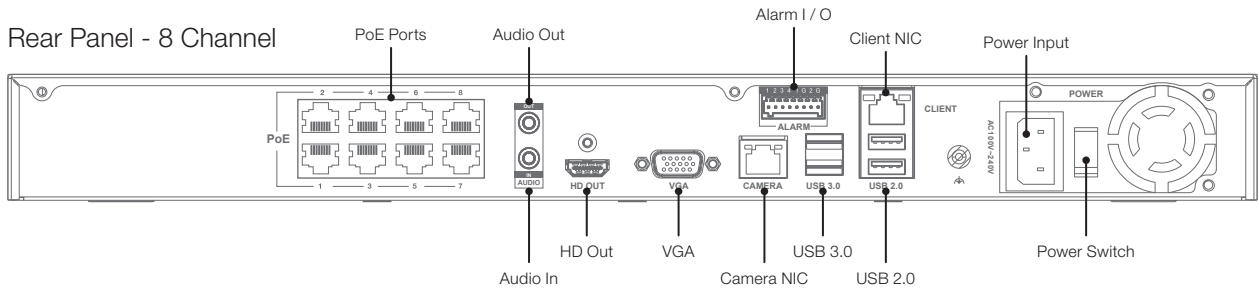

Rear Panel - 16 Channel

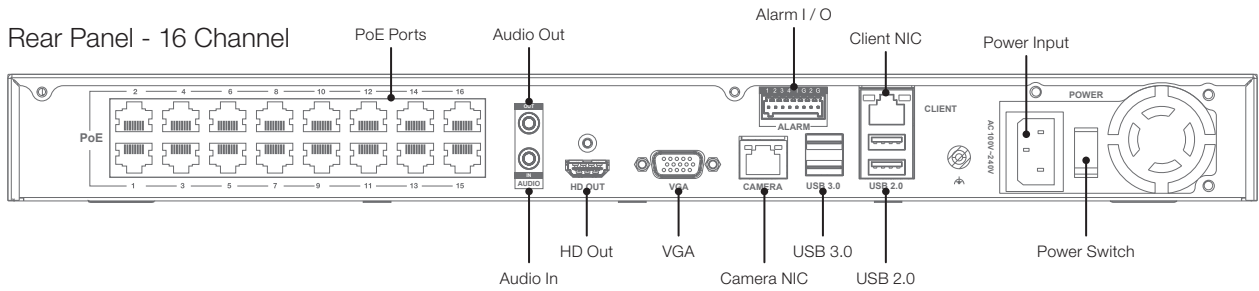

Dimensions

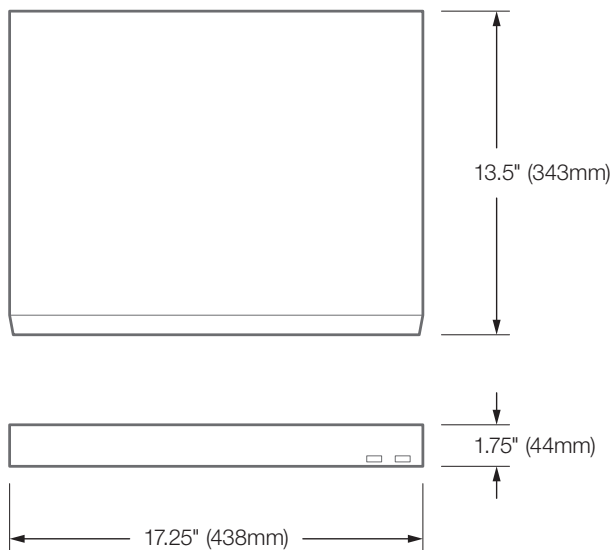

See Next Page for Ordering Information



Configurations



8 or 16 Channels

Model Numbers

8 Ch	AV-C800-2T
	AV-C800-4T
	AV-C800-6T
	AV-C800-8T
	AV-C800-12T
	AV-C800-16T
16 Ch	AV-C1600-2T
	AV-C1600-4T
	AV-C1600-6T
	AV-C1600-8T
	AV-C1600-12T
	AV-C1600-16T
	AV-C1600-20T

Software and Service Licenses

Part Number	Description
ConteraVMS®	
ConteraVMS Software Licenses	
AV-CST1	Contera® Standard 1 Channel Recording License with 1 Year ConteraWS Free
AV-CPM1	Contera Premium 1 Channel Recording License with 1 Year ConteraWS Free
AV-CPR1	Contera Professional 1 Channel Recording License with 1 Year ConteraWS Free
ConteraVMS Software Expansion Licenses	
AV-CST1-EXP	Contera Standard 1 Channel Expansion Recording License with 1 Year ConteraWS Free
AV-CPM1-EXP	Contera Premium 1 Channel Expansion Recording License with 1 Year ConteraWS Free
AV-CPR1-EXP	Contera Professional 1 Channel Expansion Recording License with 1 Year ConteraWS Free
ConteraVMS Software Upgrade Licenses	
AV-CSUBAPM	Contera Standard to Premium 1 Channel Upgrade
AV-CSUPMPR	Contera Premium to Professional 1 Channel Upgrade
ConteraWS®	
ConteraWS (Web Services) Access License Including Software Updates	
AV-CWS1Y	Contera 1 Year ConteraWS 1 Channel Access License
AV-CWS4Y	Contera 4 Year ConteraWS 1 Channel Access License
AV-CWS4Y-PROMO	Contera 4 Year ConteraWS 1 Channel Access License 16 Channel Promotion (Must be 16 Channel minimum and deployed on Contera hardware)
ConteraWS (Web Services) Cloud Storage Expansion	
AV-CWS1Y50GB	ConteraWS 50GB Cloud Storage Expansion (1 Year)

Create Your Model (Example: AV-C1600-20T)

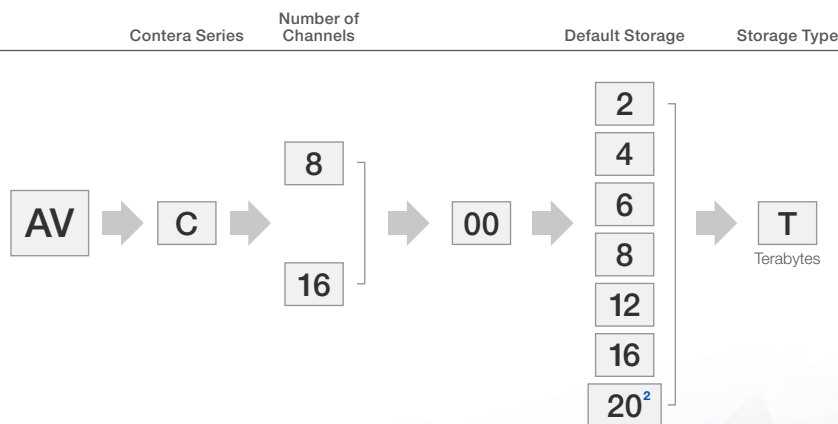

² 16 channel models only

Arecont Vision®
A COSTAR COMPANY

+1.818.937.0700 | www.arecontvision.com | avsales@arecontvision.com

© 2019 Arecont Vision Costar, LLC. All rights reserved. Arecont Vision and the Arecont Vision logo, Contera, ConteraCMR, ConteraP, ConteraVMS, ConteraWS, and ConteraMobile are registered trademarks of the company. MegalP is a business use trademark of the company.

Rev 001.005

