



# OMNI 960

## Analog Solutions



## Digital Video Recorders

**Omni960-4**

**Omni960-8**

**Omni960-16**

**Omni960-32**

# Quick Installation Guide

# TABLE OF CONTENTS

<b>DVR Pre-Installation</b> .....	2
<b>DVR Installation</b> .....	2
<b>Hard Disk Installation</b> .....	2
<b>Front Panels</b> .....	4
OMNI960-4/8/16.....	4
OMNI960-32 .....	6
<b>Rear Panels</b> .....	8
OMNI960-4 .....	8
OMNI960-8.....	8
OMNI960-16 .....	8
OMNI960-32 .....	9
<b>Peripheral Connections</b> .....	10
<b>Wiring of Alarm Input (OMNI960-32 only)</b> .....	10
<b>Wiring of Alarm Output</b> .....	10
Alarm Connection.....	10
RS-485 Connections.....	11
<b>Specifications</b> .....	12
Specifications for OMNI960-4/8/16.....	12
Specifications for OMNI960-32 .....	13
<b>HDD Storage Calculation Chart</b> .....	14
<b>Menu Operation</b> .....	15
Menu Structure .....	15
Startup and Shutdown.....	15
Using the Setup Wizard .....	16
Live View .....	16
PTZ Control.....	18
Record .....	19
Playback .....	19
Instant playback by channel .....	19
All-day Playback by channel .....	20
Backup.....	21

Thank you for purchasing our product. If there is any question or request, please do not hesitate to contact your dealer. KT&C Certified Dealers can contact KT&C directly.

## DVR Pre-Installation

OMNI960 Series DVRs are highly advanced surveillance equipment that should be installed with care. Please take into consideration the following precautionary steps before installation of the DVR.

1. Keep all liquids away from the DVR.
2. Install the DVR in a well-ventilated and dust-free area.
3. Ensure environmental conditions meet factory specifications.
4. Install a manufacturer recommended HDD.

## DVR Installation

During the installation of the DVR:

1. Use brackets for rack mounting 8/16/32 channel DVRs; for the 8/16 channel models, order optional accessory brackets KA-ORM1.
2. Ensure there is ample room for audio and video cables.
3. When installing cables, ensure that the bend radius of the cables are no less than five times than its diameter.
4. Connect alarm and RS-485 cable where applicable.
5. Allow at least 2cm (≈0.75-inch) of space between rack-mounted devices.
6. Ensure the DVR is grounded.
7. Environmental temperature should be within the range of -10 °C ~ 55 °C, 14°F ~ 131°F.
8. Environmental humidity should be within the range of 10% ~ 90%.

## Hard Disk Installation

### *Before you start:*

Before installing a hard disk drive (HDD), please make sure the power is disconnected from the DVR. A factory recommended HDD should be used for this installation.

**Tools Required:** Screwdriver.

### *Steps*

1. Remove the cover from the DVR by unfastening the screws on the back and side.



2. Install the HDD in the HDD rack using the provided screws. Fasten the screws on the bottom to fix the HDD.

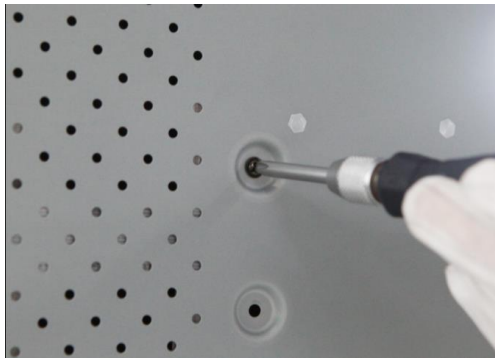

3. Connect the HDD to the motherboard of the DVR with the included data cable.

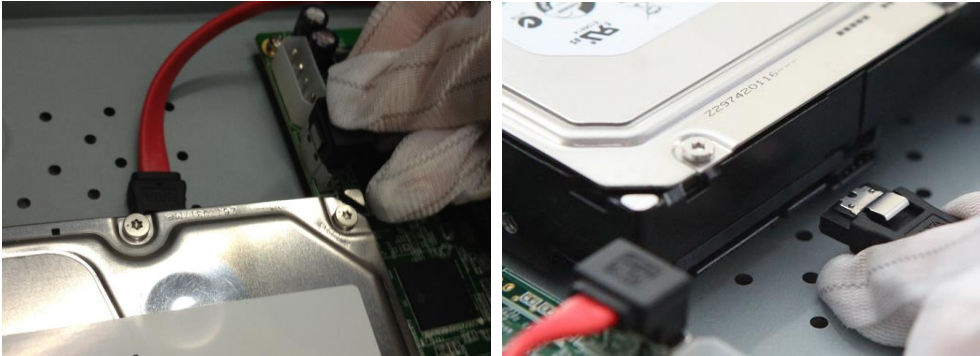

4. Connect the power cable to the HDD.

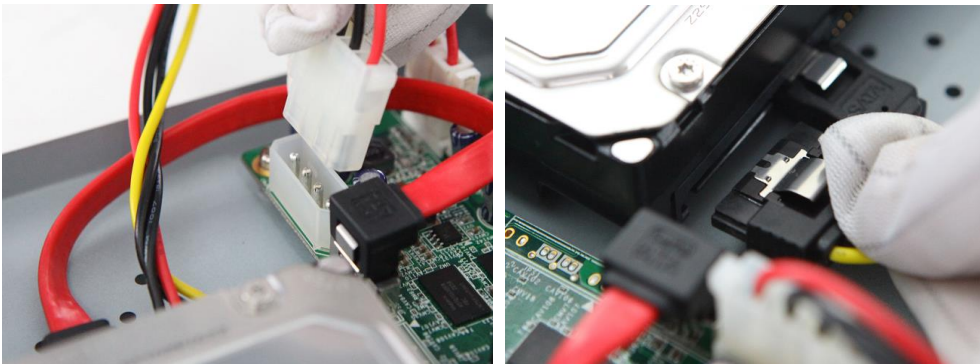

5. Re-install the cover of the DVR and fasten screws.

## Front Panels

### OMNI960-4/8/16

The front panel of the 1RU chassis model DVRs is shown below:

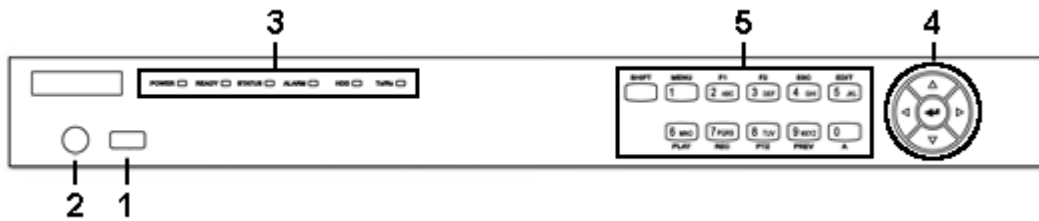

Table 1: Description of 1RU Chassis Control Panel Buttons

No.	Name	Function Description
1	<b>USB Interface</b>	Connect to USB mouse or USB flash memory.
2	<b>IR Receiver</b>	Receiver for IR remote control
3	<b>POWER</b>	Power indicator lights in green when DVR is powered up.
	<b>READY</b>	Ready indicator is normally green, indicating that the DVR is functioning properly.
	<b>STATUS LEDs</b>	Indicator turns green when DVR is controlled by an IR remote control with the address from 1~254; Indicator turns red when the SHIFT button is used; Indicator does not light when the DVR is controlled by a keyboard or by the IR remote control with the address of 255; Indicator turns green when the DVR is controlled by IR remote control (with the address from 1~254) and keyboard at the same time, and the SHIFT button is not used; Indicator turns orange : (a) when the DVR is controlled by IR remote control (with the address from 1~254) and keyboard at the same time and the SHIFT button is used as well; (b) when the DVR is controlled by IR remote control (with the address from 1~254) and the SHIFT button is used.
	<b>ALARM</b>	Alarm indicator turns red when certain alarms are detected. (8 & 16 channel OMNI DVRs only).
	<b>HDD</b>	HDD indicator blinks in red when data is being read from or written to HDD. (8 & 16 channel OMNI DVRs only).
	<b>Tx/Rx</b>	TX/RX indicator blinks in green when network connection is functioning properly. (8 & 16 channel OMNI DVRs only).
4	<b>DIRECTION ARROW BUTTONS</b>	The DIRECTION buttons are used to navigate between different fields and items in menus. In Playback mode, the Up and Down button is used to speed up and slow down recorded video. In All-day Playback mode, the Left/Right button can be used to select the recorded video of next/previous day; in Playback by Normal Video Search, the Left/Right button can be used to select the next/previous recorded file. In Live View mode, the directional buttons can be used to cycle through channels. In PTZ control mode, it can control the movement of the PTZ camera.
	<b>ENTER</b>	Confirm selection in any of the menu modes. It can also be used to tick checkbox fields. In Playback mode, it can be used to play or pause the video. In Single-frame Playback mode, pressing the ENTER button will advance the video by a single frame. In Auto-switch mode, it can be used to stop /start auto switch.
5	<b>SHIFT</b>	Switch of compound keys between the numeric/letter input and functional control.
	<b>1/MENU</b>	Enter numeral "1"; Access the main menu interface.
	<b>2ABC/F1</b>	Enter numeral "2";

	<p>Enter letters “ABC”;                  The F1 button can be used to select all items on the list;                  In PTZ Control mode, the F1 button can be used to zoom out (zoom-) the PTZ camera;                  In live view or playback mode, the F1 button can be used to switch between main and spot video output.</p>
<b>3DEF/F2</b>	<p>Enter numeral “3”;                  Enter letters “DEF”;                  In PTZ Control mode, the F2 button can be used to zoom in (zoom+) the PTZ camera;                  The F2 button can be used to cycle through tab pages.</p>
<b>4GHI/ESC</b>	<p>Enter numeral “4”;                  Enter letters “GHI”;                  Exit and back to the previous menu.</p>
<b>5JKL/EDIT</b>	<p>Enter numeral “5”;                  Enter letters “JKL”;                  Delete characters before cursor;                  Select the checkbox and ON/OFF switch;                  Start/stop record clipping in playback.</p>
<b>6MNO/PLAY</b>	<p>Enter numeral “6”;                  Enter letters “MNO”;                  In Playback mode, it is used for direct access to playback interface.</p>
<b>7PQRS/REC</b>	<p>Enter numeral “7”;                  Enter letters “PQRS”;                  Manual record, for direct access to manual record interface; manually enable/disable record.</p>
<b>8TUV/PTZ</b>	<p>Enter numeral “8”;                  Enter letters “TUV”;                  Access PTZ control interface.</p>
<b>9WXYZ/PREV</b>	<p>Enter numeral “9”;                  Enter letters “WXYZ”;                  Multi-camera display in live view;                  In Playback mode or Menu→Playback→Tag playback interface, this button can be used to delete the selected tag.</p>
<b>0/A</b>	<p>Enter numeral “0”;                  Switch between input character choices (upper and lowercase alphabet, symbols and numeric input).                  In Playback mode, this button can be used to add the default tag.</p>

## OMNI960-32

The front panel of the 1.5RU 32 channel model is shown below:

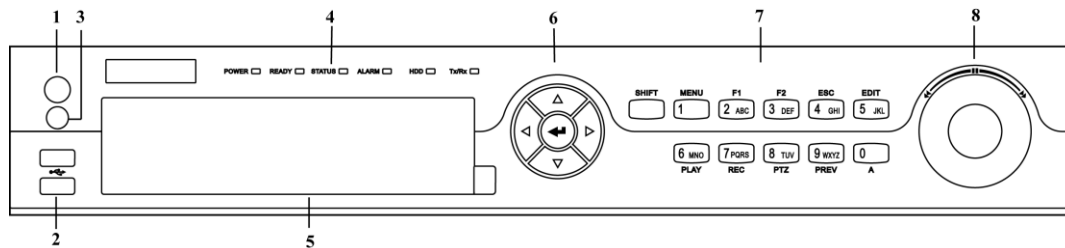

Table 2: Description of 1.5RU Chassis Control Panel Buttons

No.	Name	Function Description
1	<b>POWER ON/OFF</b>	Power on/off switch.
2	<b>USB Interface</b>	Connect to USB mouse or USB flash memory.
3	<b>IR Receiver</b>	Receiver for IR remote control.
4	<b>POWER</b>	Power indicator lights in green when DVR is powered up.
	<b>READY</b>	Ready indicator is normally green, indicating that the DVR is functioning properly.
	<b>STATUS</b>	Indicator turns green when DVR is controlled by an IR remote control with the address from 1~254; Indicator turns red when the SHIFT button is used; Indicator does not light when the DVR is controlled by a keyboard or by the IR remote control with the address of 255; Indicator turns green when the DVR is controlled by IR remote control (with the address from 1~254) and keyboard at the same time, and the SHIFT button is not used; Indicator turns orange : (a) when the DVR is controlled by IR remote control (with the address from 1~254) and keyboard at the same time and the SHIFT button is used as well; (b) when the DVR is controlled by IR remote control (with the address from 1~254) and the SHIFT button is used.
	<b>ALARM</b>	Alarm indicator turns red when a sensor alarm is detected.
	<b>HDD</b>	HDD indicator blinks in red when data is being read from or written to HDD.
	<b>Tx/Rx</b>	TX/RX indicator blinks in green when network connection is functioning properly.
5	<b>DVD-ROM</b>	Slot for DVD-ROM.
6	<b>DIRECTION</b>	The DIRECTION buttons are used to navigate between different fields and items in menus. In Playback mode, the Up and Down button is used to speed up and slow down recorded video. In All-day Playback mode, the Left/Right button can be used to select the recorded video of next/previous day; in Playback by Normal Video Search, the Left/Right button can be used to select the next/previous recorded file. In Live View mode, the directional buttons can be used to cycle through channels. In PTZ control mode, it can control the movement of the PTZ camera.
	<b>ENTER</b>	Confirm selection in any of the menu modes. It can also be used to tick checkbox fields. In Playback mode, it can be used to play or pause the video. In Single-frame Playback mode, pressing the ENTER button will advance the video by a single frame. In Auto-switch mode, it can be used to stop /start auto switch.
7	<b>SHIFT</b>	Switch of compound keys between the numeric/letter input and functional control.
	<b>1/MENU</b>	Enter numeral "1"; Access the main menu interface.
	<b>2ABC/F1</b>	Enter numeral "2"; Enter letters "ABC"; The F1 button can be used to select all items on the list; In PTZ Control mode, the F1 button can be used to zoom out (zoom-) the PTZ camera; In live view or playback mode, the F1 button can be used to switch between main and spot video output.
	<b>3DEF/F2</b>	Enter numeral "3";

		<p>Enter letters “DEF”;                  In PTZ Control mode, the F1 button can be used to zoom in (zoom+) the PTZ camera;                  The F2 button can be used to cycle through tab pages.</p>
	<b>4GHI/ESC</b>	<p>Enter numeral “4”;                  Enter letters “GHI”;                  Exit and back to the previous menu.</p>
	<b>5JKL/EDIT</b>	<p>Enter numeral “5”;                  Enter letters “JKL”;                  Delete characters before cursor;                  Select the checkbox and ON/OFF switch;                  Start/stop record clipping in playback.</p>
	<b>6MNO/PLAY</b>	<p>Enter numeral “6”;                  Enter letters “MNO”;                  In Playback mode, it is used for direct access to playback interface.</p>
	<b>7PQRS/REC</b>	<p>Enter numeral “7”;                  Enter letters “PQRS”;                  Manual record, for direct access to manual record interface; manually enable/disable record.</p>
	<b>8TUV/PTZ</b>	<p>Enter numeral “8”;                  Enter letters “TUV”;                  Access PTZ control interface.</p>
	<b>9WXYZ/PREV</b>	<p>Enter numeral “9”;                  Enter letters “WXYZ”;                  Multi-camera display in live view;                  In Playback mode or Menu → Playback → Tag playback interface, this button can be used to delete the selected tag.</p>
	<b>0/A</b>	<p>Enter numeral “0”;                  Switch between input methods (upper and lowercase alphabet, symbols and numeric input).                  In Playback mode, this button can be used to add the default tag.</p>
<b>8</b>	<b>JOG SHUTTLE Control</b>	<p>Move the active selection in a menu. The inner ring will move the selection up and down; the outer ring will move it left and right.                  In Playback mode, the inner ring is used to jump 30s forward/backward in video files. The outer ring can be used to speed up/slow down the video.                  In Live View mode, it can be used to cycle through different channels.                  In PTZ control mode, it can control the movement of the PTZ camera.</p>



# Rear Panels

## OMNI960-4

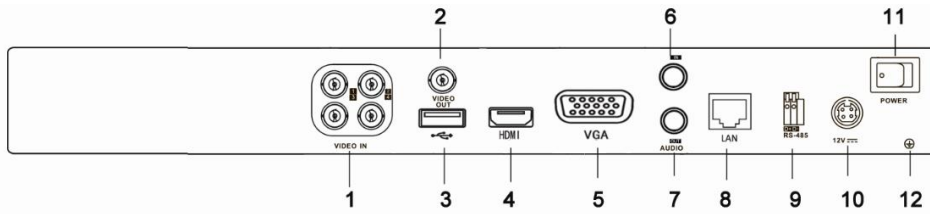

## OMNI960-8

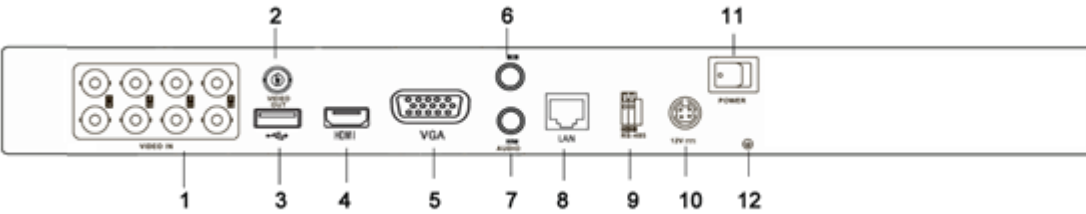

## OMNI960-16

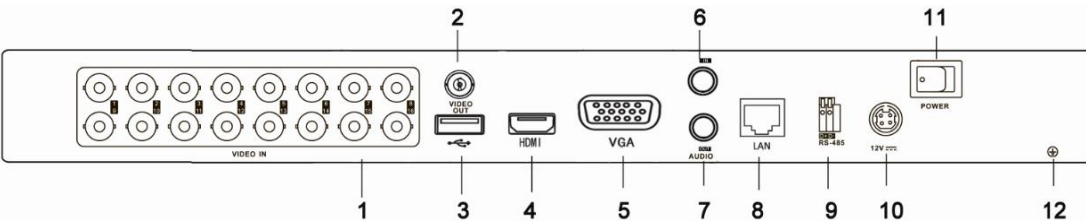

Table 3: Description of 4/8/16 Channel Rear Panels

No.	Item	Description
1	<b>VIDEO IN</b>	BNC connector for analog video input.
2	<b>VIDEO OUT</b>	BNC connector for video output.
3	<b>USB Interface</b>	Connects USB mouse or USB flash memory devices.
4	<b>HDMI</b>	HDMI video output.
5	<b>VGA</b>	DB15 connector for VGA output. Display local video output and menu.
6	<b>AUDIO IN</b>	RCA connector for audio input.
7	<b>AUDIO OUT</b>	RCA connector for audio output.
8	<b>LAN Interface</b>	RJ45 10M / 100M Ethernet interface.
9	<b>RS-485 Interface</b>	Connector for RS-485 devices. Connect the D+ and D- terminals to R+ and R- terminals of PTZ receiver respectively.
10	<b>12V</b>	12VDC power supply.
11	<b>POWER</b>	Switch for turning on/off the device.
12	<b>GND</b>	Ground(needs to be connected when DVR starts up)

## OMNI960-32

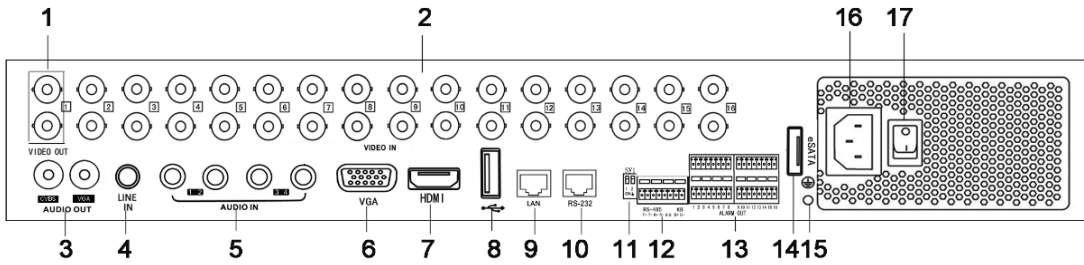

Table 4 Description of 32 Channel Rear Panel

No.	Item	Description
1	<b>MAIN VIDEO OUT</b>	BNC connector for video output.
	<b>SPOT VIDEO OUT</b>	BNC connector for spot video output.
2	<b>VIDEO IN</b>	BNC connector for analog video input.
3	<b>CVBS AUDIO OUT</b>	RCA connector for audio output. This connector is synchronized with CVBS video output.
	<b>VGA AUDIO OUT</b>	RCA connector for audio output. This connector is synchronized with VGA video output.
4	<b>LINE IN</b>	RCA connector for two-way audio input.
5	<b>AUDIO IN</b>	RCA connector for audio input.
6	<b>VGA</b>	DB15 connector for VGA output. Display local video output and menu.
7	<b>HDMI</b>	HDMI video output.
8	<b>USB Interface</b>	Connects USB mouse or USB flash memory devices.
9	<b>LAN Interface</b>	RJ45 10M / 100M / 1000M Ethernet interface.
10	<b>RS-232</b>	Connector for RS-232 devices.
11	<b>Termination Switch</b>	RS-485 termination switch. Up position is not terminated. Down is terminated with 120Ω resistance.
12	<b>RS-485 Interface</b>	Connector for RS-485 devices. Connect the T+ and T- terminals to the R+ and R- terminals of PTZ receiver respectively.
	<b>KB</b>	Connect the D+ and D- terminals to Ta and Tb terminals of the controller. For cascading devices, the first DVR's D+ and D- terminals should be connected with the D+ and D- terminals of the next DVR.
13	<b>Alarm In/Out</b>	Connector for alarm input/output.
14	<b>eSATA</b>	Connects external SATA HDD, DVD-R/W.
15	<b>GND</b>	Ground(needs to be connected when DVR starts up)
16	<b>100~240VAC</b>	100~240VAC power supply.
17	<b>POWER</b>	Switch for turning on/off the device.

# Peripheral Connections

## Wiring of Alarm Input (OMNI960-32 only).

The alarm input is an open/closed relay. To connect the alarm input to the device, use the following diagram.

**Note:** If the alarm input is not an open/close relay, please connect an external relay between the alarm input and the device.

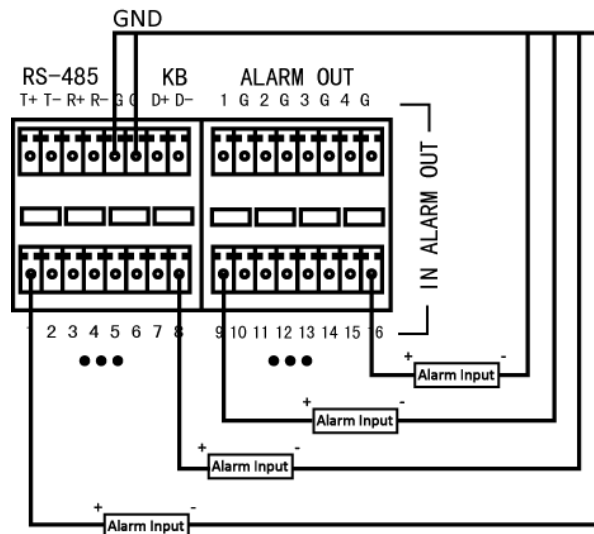

## Wiring of Alarm Output

To connect to an alarm output (AC or DC load), use the following diagram:

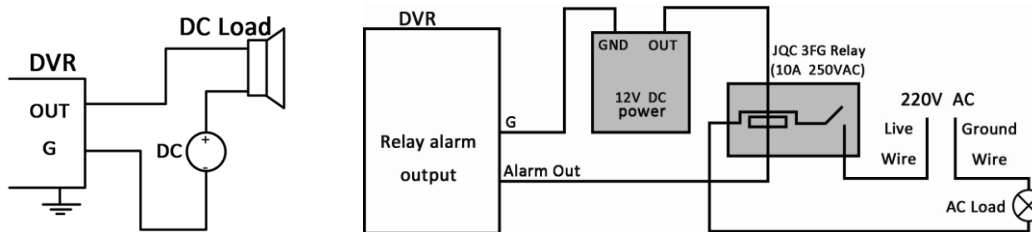

DC Load Connection Diagram

AC Load Connection Diagram

For DC low current load, the jumpers can be used within the limit of 12V/1A safely.

To connect an AC load or DC high current load, jumpers should be left open (you must remove the jumper on the motherboard in the NVR). Use an external relay for safety (as shown in the figure above).

There are 4 jumpers (JP1, JP2, JP3, and JP4) on the motherboard, each corresponding with one alarm output. By default, jumpers are connected. To connect an AC load, jumpers should be removed.

**Example:**

If you connect an AC load to the alarm output 3 of the DVR, then you must remove the JP 3.

## Alarm Connection

To connect alarm devices to the DVR:

1. Disconnect *pluggable block* from the ALARM IN /ALARM OUT terminal block.
2. Press and hold the orange part of the *pluggable block*; insert signal cables into slots and release the orange part. Ensure signal cables are in tight.

Connect *pluggable block* back into terminal block

**Note:** Alarm input/output connections are valid for the OMNI960-32 models only.

## RS-485 Connections

### For OMNI960-4/8/16 DVRs

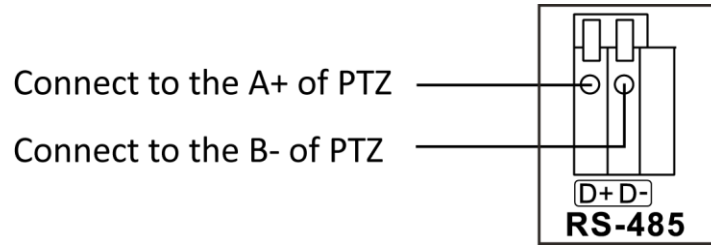

#### To connect PTZ to the DVR:

1. Disconnect *pluggable block* from the RS-485 terminal block.
2. Press and hold the orange part of the *pluggable block*; insert signal cables into slots and release the orange part. Ensure signal cables are in tight.
3. Connect A+ on PTZ to D+ on terminal block and B- on controller to D- on terminal block. Fasten stop screws.
4. Connect *pluggable block* back into terminal block.

### For OMNI960-32 DVR

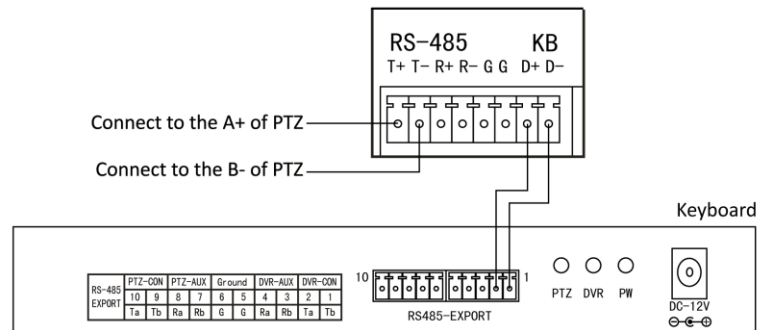

#### To connect PTZ to the DVR:

1. Disconnect *pluggable block* from the RS-485 terminal block.
2. Press and hold the orange part of the *pluggable block*; insert signal cables into slots and release the orange part. Ensure signal cables are in tight.
3. Connect A+ on PTZ to T+ on terminal block and B- on controller to T- on terminal block. Fasten stop screws.
4. Connect *pluggable block* back into terminal block.

#### To connect a controller to the DVR:

1. Disconnect *pluggable block* from the KB terminal block.
2. Press and hold the orange part of the *pluggable block*; insert signal cables into slots and release the orange part. Ensure signal cables are in tight.
3. Connect Ta on controller to D+ on terminal block and Tb on controller to D- on terminal block. Fasten stop screws.
4. Connect *pluggable block* back into terminal block.

**Note:** Make sure both the controller and DVR are grounded. Here we take the controller connection of one model as an example.

**Note:** Make sure the pan/tilt receiver unit is connected to the T+ and T- of the RS-485 terminal of the OMNI960-32 DVR.

# Specifications

## Specifications for OMNI960-4/8/16

Model		OMNI960-4	OMNI960-8	OMNI960-16
Video/Audio input	Video compression	H.264		
	Video input	4-ch	8-ch	16-ch
	Video input interface	BNC (1.0 V <sub>p-p</sub> , 75 Ω), PAL /NTSC self-adaptive		
	Audio compression	G.711		
	Audio input	1-ch, RCA (2.0 V <sub>p-p</sub> , 1 kΩ)		
	Two-way audio input	1-ch, RCA (2.0 V <sub>p-p</sub> , 1 kΩ) (using the audio input)		
Video/Audio output	HDMI/VGA output	1080P: 1920×1080/60Hz; SXGA: 1280×1024/60Hz; 720P: 1280×720/60Hz; XGA: 1024×768/60Hz		
	CVBS output	1-ch, BNC (1.0 V <sub>p-p</sub> , 75 Ω), resolution: PAL: 704 × 576, NTSC: 704 × 480		
	Encoding resolution	WD1 / 4CIF / 2CIF / CIF / QCIF		
	Frame rate	25 fps (P) / 30 fps (N)		
	Video bit rate	32 Kbps ~ 3072 Kbps, or user defined (Max. 3072 Kbps)		
	Audio output	1-ch, RCA (Linear, 1 kΩ)		
	Audio bit rate	64 Kbps		
	Dual-stream	Support; sub-stream @ CIF/ QCIF		
	Stream type	Video, Video & Audio		
	Synchronous playback	4-ch	8-ch	16-ch
Hard disk	SATA	1 SATA interface	2 SATA interfaces	
	Capacity	Up to 4TB capacity for each disk		
External interface	Network interface	1, RJ45 10M / 100M Ethernet interface		
	Serial interface	1 RS-485 interface, half-duplex		
	USB interface	2, USB 2.0		
General	Power supply	12 VDC		
	Consumption (without hard disk or DVD-R/W)	≤ 10 W	≤ 15 W	≤ 20 W
	Working temperature	-10 °C ~+55 °C		
	Working humidity	10% ~ 90%		
	Chassis	Standalone 1U chassis	19-inch rack-mountable 1U chassis	
	Dimensions (W × D × H)	315 × 230 × 45 mm	445 × 290 × 45mm	
	Weight (without hard disk or DVD-R/W)	≤ 2 kg	≤ 4 kg	≤ 4 kg

## Specifications for OMNI960-32

Video/Audio input	Video compression	H.264
	Video input	32-ch
	Video input interface	BNC (1.0 Vp-p, 75 Ω), PAL /NTSC self-adaptive
	Audio compression	G.711u
	Audio input	4-ch, RCA (2.0 Vp-p, 1 kΩ)
	Two-way audio input	1-ch, RCA (2.0 Vp-p, 1 kΩ) (using the audio input)
Video/Audio output	HDMI/VGA output	1-ch, resolution: 1080P: 1920×1080/60Hz, SXGA: 1280×1024/60Hz, 720P: 1280×720/60Hz, XGA: 1024×768/60Hz
	CVBS output	1-ch, BNC (1.0 Vp-p, 75 Ω), resolution: PAL: 704 × 576, NTSC: 704 × 480
	Video spot out	1-ch, BNC (1.0 Vp-p, 75 Ω), resolution: PAL: 704 × 576, NTSC: 704 × 480
	Encoding resolution	WD1 / 4CIF / 2CIF / CIF / QCIF
	Frame rate	25 fps (P) / 30 fps (N)
	Video bit rate	32 Kbps ~ 3072 Kbps, or user defined (Max. 3072 Kbps)
	Audio output	2-ch, RCA (Linear, 600 Ω)
	Audio bit rate	64 Kbps
	Dual-stream	Support; Sub-stream: CIF / QCIF @ 25 fps (P) / 30 fps (N)
	Stream type	Channel 1-4: Video, Video & Audio; Other channels: Video
	Synchronous playback	16-ch
Hard disk	SATA	4 SATA interfaces for 2HDDs + 1 DVD-R/W (default), or 4 HDDs
	eSATA	1 eSATA interface
	Capacity	Up to 4TB capacity for each disk
External interface	Network interface	1, RJ45 10M / 100M / 1000M Ethernet interface
	Serial interface	1 RS-232, RS-485(full-duplex), Keyboard
	USB interface	3 × USB 2.0
	Alarm in	16
	Alarm out	8
General	Power supply	100~240VAC, 5A, 50~60Hz
	Consumption (without HDD or DVD-R/W)	≤ 40 W
	Working temperature	-10 °C ~+55 °C
	Working humidity	10% ~ 90%
	Chassis	19-inch rack-mountable 1.5U chassis; rack ears included
	Dimensions (W × D × H)	445 × 390 × 70 mm
	Weight (without HDD or DVD-R/W)	≤ 5 kg

## HDD Storage Calculation Chart

The following chart shows an estimation of storage space used based on recording at one channel for an hour at a fixed bit rate.

Bit Rate (Kbps)	Storage Used (MB)
96	42
128	56
160	70
192	84
224	98
256	112
320	140
384	168
448	196
512	225
640	281
768	337
896	393
1024	450
1280	562
1536	675
1792	787
2048	900
3072	1350

**Note:** Please note that supplied values for storage space used is just for reference. Storage space used is estimated by formulas and may have some deviation from actual value.

# Menu Operation

## Menu Structure

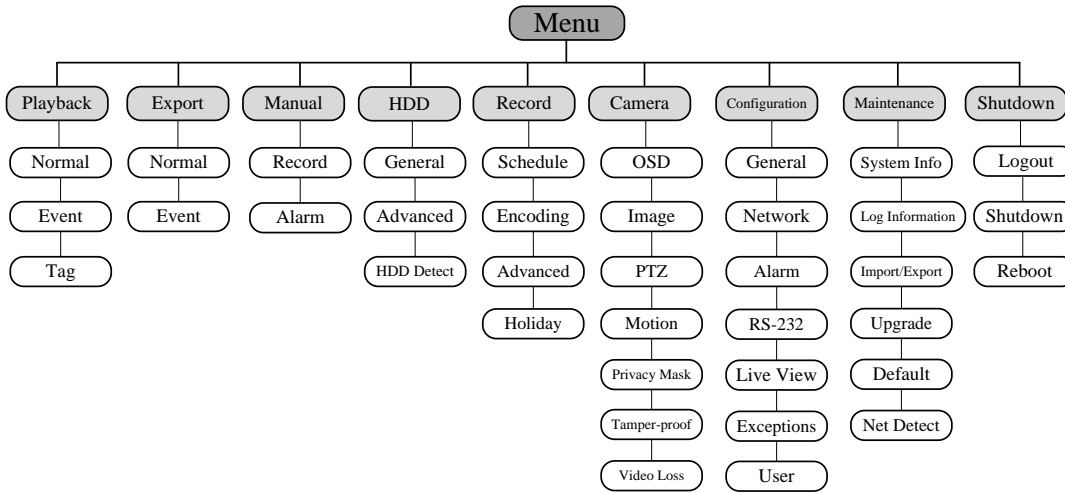

**Note:** The menu structure may differ slightly for different models depending on included features.

## Startup and Shutdown

Proper startup and shutdown procedures are crucial to expanding the life of the DVR.

### Before you start:

Check that the voltage of the extra power supply is the same with the device’s requirement, and the ground connection is working properly.

### Starting up the device:

#### Steps:

1. Check the power supply is plugged into an electrical outlet. It is **HIGHLY** recommended that an Uninterruptible Power Supply (UPS) be used in conjunction with the device.
2. Press the **POWER** button on the rear panel. The Power indicator LED should turn on.

### Shutting down the device:

#### Steps:

1. Enter the Shutdown menu.  
Menu > Shutdown



2. Click the **Shutdown** button to enter the following dialog box:



3. Click the **Yes** button.
4. Turn off the power switch on the rear panel of DVR.



## Using the Setup Wizard

The Setup Wizard can walk you through some important settings of the device. By default, the Setup Wizard starts once the device has loaded.

Operating the Setup Wizard:

1. Select the system resolution from the dropdown menu. The default resolution is 1280×1024/60Hz.

Click **Apply** to save the resolution settings.

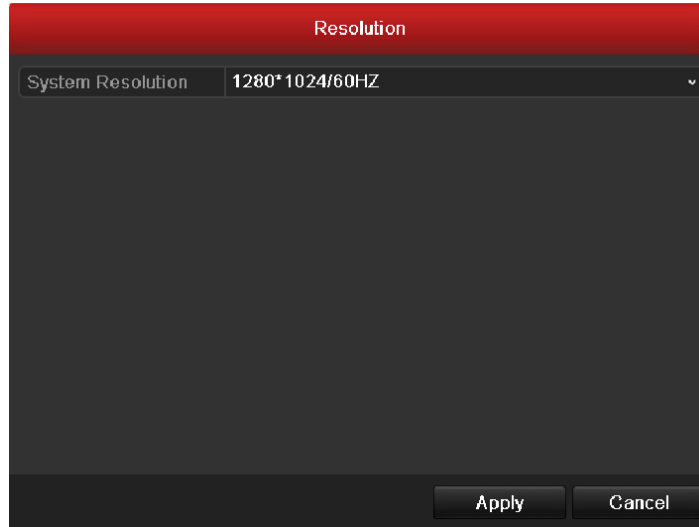

2. Check the checkbox to enable Setup Wizard when device starts. Click Next to continue the setup wizard. Follow the guide of the Setup Wizard to configure the system resolution, password modification, system date/time, network settings, HDD management, record settings, etc.

## Live View

Some icons are provided on screen in Live View mode to indicate different camera status. These icons include:

### Live View Icons

In the live view mode, there are icons at the right top of the screen for each channel, showing the status of the record and alarm in the channel, so that you can find problems as soon as possible.



Alarm (video loss, tampering, motion detection or sensor alarm).



Record (manual record, schedule record, motion detection record or alarm triggered record)

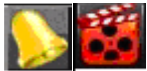

Alarm & Record

**Note:** The sensor alarm and alarm triggered record are supported by OMNI960-32 models only.

## Using the Mouse in Live View

In the live view mode, use the mouse to right-click on the window to access the top level OSD menu:

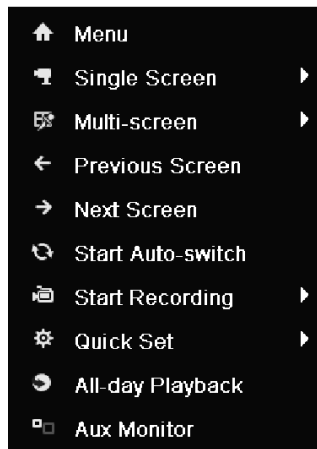

Table 4 Top Level Menu Choices

Name	Description
Menu	Enter the main system menu by left-clicking the mouse on this choice
Single Screen	Switch to the single full screen by choosing channel number from the dropdown list.
Multi-screen	Adjust the screen layout by choosing from the dropdown list.
Previous Screen	Switch to the previous screen.
Next Screen	Switch to the next screen.
Start/Stop Auto-switch	Enable/disable the auto-switch of the screens. <b>Note:</b> The <i>dwelt time</i> of the live view configuration must be set before using <b>Start Auto-switch</b> .
Start Recording	Start all-day normal recording or motion detection recording for all channels.
Quick Set	Set the video output mode to Standard, Bright, Gentle or Vivid.
All-day Playback	Play back the video of the selected channel.
Aux Monitor	Switch to the auxiliary output mode and the operation for the main output is disabled. <b>Note:</b> If you enter Aux monitor mode and the Aux monitor is not connected, the mouse operation is disabled; you need to switch back to the Main output. One way to switch between monitor selection for menu display is to double click the WHEEL BUTTON (depress the wheel) on the mouse TWICE. The first double click brings up a dialog box that says the double click again to switch. This can be accomplished with patience. On the OMNI960-32, use the <b>F1</b> button on front panel or <b>VOIP/MON</b> button on the IR remote control and then press the <b>Enter</b> button. See section below.

**Note:** If the corresponding camera supports intelligent functions, the Reboot Intelligence option is included when right-clicking mouse on this camera.

### Main/Aux Output Switching

When the HDMI/VGA output is configured as the main output, you can perform the following operation to switch to CVBS output as the main output.

**Steps:**

1. Use the mouse wheel to double-click on the HDMI/VGA output screen, and the following message box pops up:

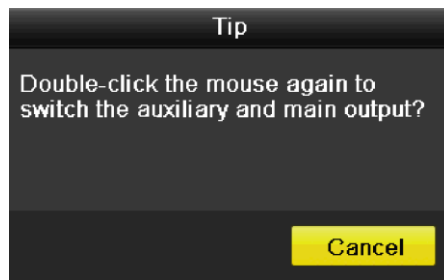

2. Use the mouse wheel to double-click on the screen again to switch to the Aux output, or click Cancel to cancel the operation.
3. On the aux output monitor, you can do some basic operation on the live view mode for the Aux output, including recording, live view, image settings, switch to main monitor, and no operation is allowed for the main output.
4. To switch to the main video output, click the **Main Monitor** icon on the toolbar or use the mouse wheel to double-click on the screen and then click **Yes** on the pop-up message box.

**Note:** You can select the Menu Output Mode under Menu>Configuration>More Settings to Auto or HDMI/VGA and then restart the device to switch the main output back to HDMI/VGA output.

### PTZ Control

Follow the procedure to set the parameters for PTZ. The configuring of the PTZ parameters should be done before you set the PTZ camera. Before you start, please check that the PTZ and the DVR are connected properly through RS-485 interface.

In the Live View mode, you can press the PTZ Control button on the IR remote control, or choose the PTZ Control icon  to enter the PTZ toolbar.

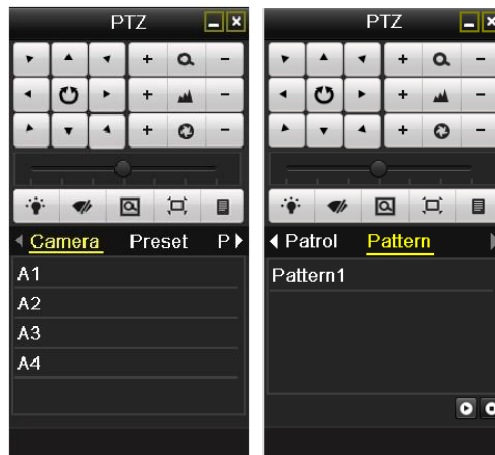

















Table 5 Description of the PTZ toolbar icons

Icon	Description	Icon	Description	Icon	Description
	Direction button and the auto-cycle button		Zoom+, Focus+, Iris+		Zoom-, Focus-, Iris-
	The speed of the PTZ movement		Light on/off		Wiper on/off
	3D-Zoom		Image Centralization		Preset
	Patrol		Pattern		Menu
	Previous item		Next item		Start pattern/patrol



## Record

You can use the right-click menu in live view mode to configure recording for all channels.

1. In the live view mode, use the mouse to right-click on the window to access the following menu:

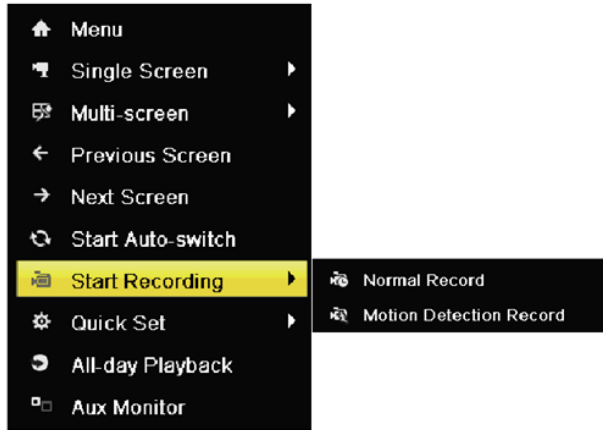

2. Click the **Start Recording** submenu and select the recording mode to **Normal Record** or **Motion Detection Record**.
3. In the pop-up message box, click **Yes** to finish the quick recording settings for all channels.

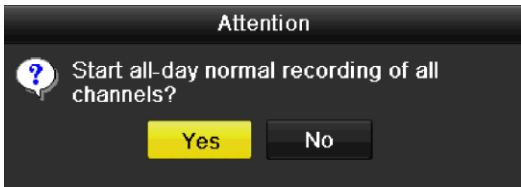

**Note:** The full-screen motion detection triggered recording is configured by default in this mode.

## Playback

Play back the record files of a specific channel in the live view menu.

### Instant playback by channel

Choose a channel under live view using the mouse and click the  button in the shortcut operation menu.

**Note:** Only record files recorded during the past five minutes on this channel will be played back.



### All-day Playback by channel

1. Enter the All-day Playback menu.

Mouse: right-click a channel in live view mode and select All-day Playback from the menu.

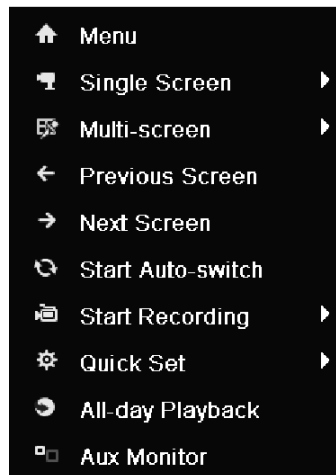

Press **PLAY** button on the front panel or IR remote control to play back record files of the channel under single-screen live view.

Under multi-screen live view, record files of the top left channel (not masked) will be played back.

2. Playback management.

The toolbar in the bottom part of Playback interface can be used to control playing process.

The channel and time selection menu will display by moving the mouse to the right of the playback interface.

Tick the channel or channels if you want to switch playback to another channel or execute simultaneous playback of multiple channels.



## Backup

Recorded files can be backed up to various devices, such as USB flash drives, USB HDDs or a DVD writer.

To export recorded files:

1. Click Menu>Export to enter Video Export interface.

Choose the channel (s) you want to back up and click the **Quick Export** button.



2. Enter Export interface, choose backup device and click **Export** button to start exporting.



3. Check backup result.

Choose the record file in Export interface and click the button to check it.



**KT&C America, Inc.**  
[www.ktncusa.com](http://www.ktncusa.com)

**New Jersey Office**

40 Lane Road 1st Floor  
Fairfield, NJ 07004

T: 973 276 0118

F: 973 276 0 116

**New York Office**

200 Pkwy Drive South Suite 200  
Hauppauge, NY 11788

T: 631 864 0118

F: 631 864 0116

**California Office**

3240 Wilshire Blvd Suite 501  
Los Angeles, CA 90010

T: 213 381 0061

F: 213 381 0064