

Z952

4MP Outdoor Speed Dome with D/N, Adaptive IR, Extreme WDR, ELLS, 25x Zoom Lens



- 4 Megapixel
- Day & Night with Extreme Low Light Sensitivity and Adaptive IR LED
- Extreme WDR
- Endless Pan & Tilt, PTZ Auto Tracking
- H.265 Compression
- Event trigger, response and notification

► Specifications

Device

Product Type	Speed Dome
Maximum Resolution	4MP
Application Environment	Outdoor
Image Sensor	Progressive Scan CMOS
Sensor Size	1/2.8 "
Effective Pixels	2592(H) X 1944(V) (5.04 MP)
Day / Night	Yes
Low Light Sensitivity	Extreme
Minimum Illumination	Color: 0.003 lux at F1.5 (AGC on); B/W: 0 (IR LED on)
Mechanical IR Cut Filter	Yes
IR LED	Adaptive IR LED
IR Working Distance	150m (1.0 lux at tele mode)
Electronic Shutter	1-1/100000 second (manual mode); 1-1/100000 second (auto mode)
S/N Ratio	75 dB

Lens	
Focal Length	Zoom, f4.8-120mm
Aperture	F1.5-F3.8
Zoom Ratio	25x optical zoom, unlimited digital zoom (via web browser)
Iris	DC iris
Focus	Auto focus
Horizontal Viewing Angle	55.3° - 3.2°
Vertical Viewing Angle	56° - 2.1°

PTZ	
Manual Panning / Tilting Speed	0.1° - 200°/second, 0.1° - 120°/second
Preset Panning / Tilting Speed	240°/second, 200°/second
Panning Range	360° endless
Tilting Range	-15°~90° (with E-flip)
PTZ Control	Remote manual control, 1024 preset points, 16 preset tours
Absolute Position	Yes
Pan, Tilt or Zoom protocol	Pelco-D, Pelco-P

Video	
Compression	H.265, H.264, MJPEG
Maximum Frame Rate vs. Resolution	30 fps at 2688 x 1520 30 fps at 2560 x 1440 30 fps at 1920 x 1080 30 fps at 1280 x 720 30 fps at 720 x 576 30 fps at 704 x 288 30 fps at 640 x 360 30 fps at 352 x 288
Multi-Streaming	Simultaneous triple streams
Wide Dynamic Range	Extreme WDR (140 dB)
Image Enhancement	White Balance, Backlight compensation (BLC), Defogging
Digital Noise Reduction	2D + 3D DNR
Privacy Mask	24 configurable regions
Built-in Analytics	People Counting, Face Detection, PTZ Auto Tracking, Tampering Detection, Intrusion Detection (Forbidden Area Detection), Object Line Crossing Detection, Object Enter Area Detection, Object Exit Area Detection
Image Orientation	Flip, Mirror, Rotation (Corridor mode)

Audio	
Audio Type	2-way, Line-in, Line-out
Audio Compression	G.711 u-law, G.711 A-law

Network	
Network Protocol & Service	IPv4, TCP, UDP, DHCP, PPPoE, HTTP, HTTPS, DNS, DDNS, NTP, RTP, RTSP, RTCP, SMTP, FTP, IGMP, ICMP, ARP, UPnP, QoS, SSL/TLS, IEEE 802.1X
Ethernet Port	1 x Ethernet (10/100 Base-T), RJ-45 pigtail connector
Maximum User Connections	32

Security	IP address filtering, HTTPS encryption, Password protected user level, IEEE 802.1X network access control
----------	---

Event

Event Trigger	Video motion detection, Tampering detection, Sound detection, External device through digital input,
Event Response	E-mail notification with snapshots, Upload snapshot to FTP server, Save video or snapshot to local storage

Integration

ONVIF Compliant	Yes, Profile S, Profile G, Profile T
Web Browser	IE 11, Google Chrome, Microsoft Edge, Firefox

Interface

Serial Port	1 x RS-485
Analog Video Output	1 x BNC connector
Local Storage	MicroSD Memory Card Slot (card not included, up to 256GB, Kingston or Sandisk only)
Digital Input/Output	2/1
Operating Button	Reset Button

General

Power Source	DC 12V, High PoE (IEEE802.3at)
Power Consumption	21 W (PoE)
Weight	3200g (7.05lb)
Dimensions	(Ø x H): 166mm x 295mm (6.5" x 11.6")
Environmental Casing	Weatherproof (IP66), Vandal proof (IK10)
Corrosion Protection	Optional for project request. Chassis corrosion resistance at the seashore approximately 2-3 years.
Bundled Accessories	Power Adapter (DC 12V)
Operating Temperature	-40°C ~ 65°C (-40°F ~ 149°F)
Operating Humidity	≤95% RH
Surge Protection	6KV
Approvals	CE Class B, FCC Class B, IP66, IK10, UL Listed
Color	White
Real-time Clock (RTC)	Yes
Warranty	2 Year(s). For extended warranty offering, see http://www.acti.com/support/warranty

► Photo Indication

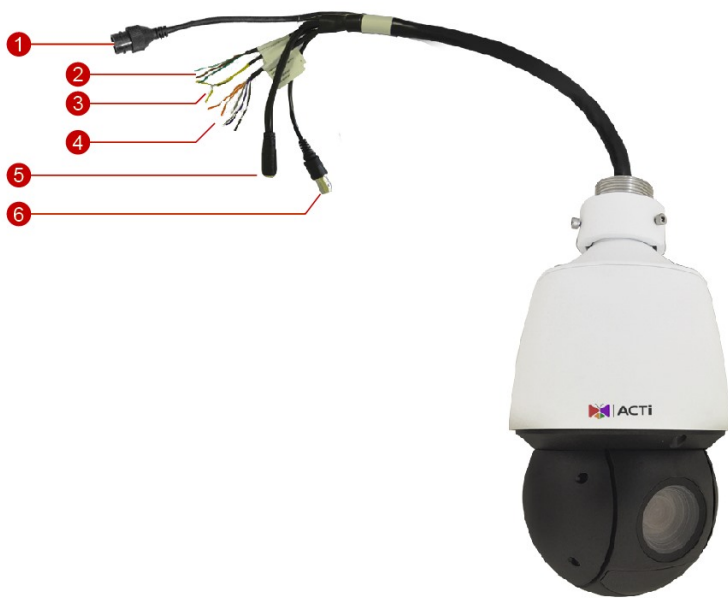

- 1 Ethernet Port
- 2 Audio Input / Output
- 3 Serial Port
- 4 Digital Input / Output
- 5 DC 12V Power Input
- 6 Analog Video Output



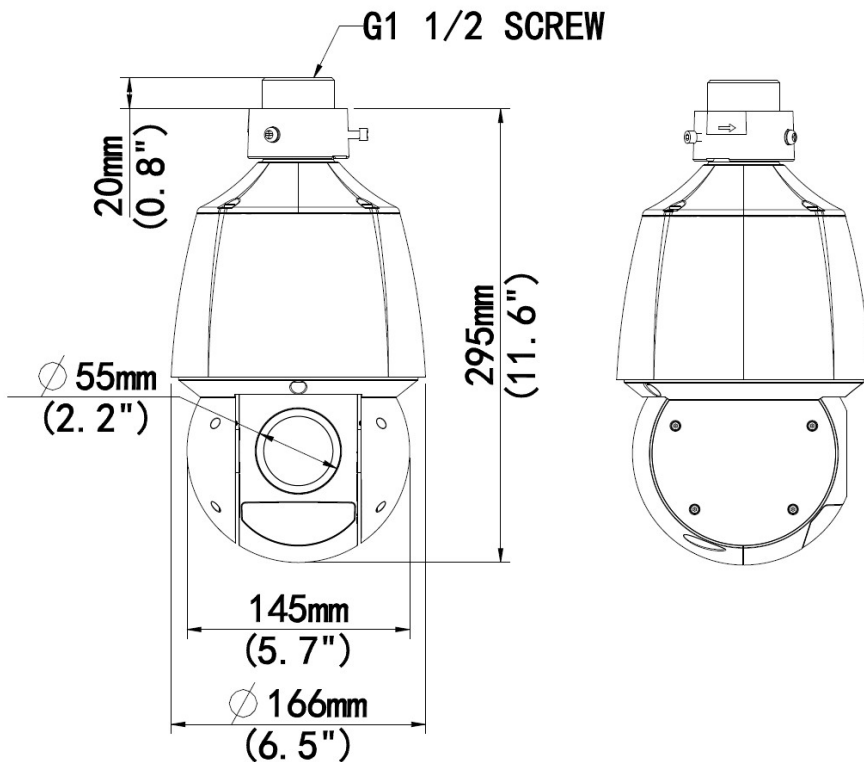













► Dimension Diagram



Unit: mm [inch]

► Related Products

Mounting Accessories - Camera Mount

PMAX-0104		Extension Tube
PMAX-0115		Pendant Mount (for A950, A951, A952, A956, Z950, Z952)
PMAX-0116		Straight Tube, 200 mm (for Z950)
PMAX-0117		Straight Tube (for Z950, Z952)
PMAX-0125		Straight Tube with Converter Ring (for Q75)
PMAX-0126		Straight Tube with Bracket and Converter Ring (for Q75)
PMAX-0322		Wall mount (for Z950, Z952)
PMAX-0346		Heavy Duty Wall Mount with Converter Ring (for Q75, A950, A951, A952, A956)
PMAX-0402		Corner Mount
PMAX-0404		Corner Mount (for Z950, Z952)
PMAX-0503		Pole Mount (for PMAX-0102, PMAX-0312, PMAX-0313, PMAX-0314, PMAX-0702, PMAX-1106, PMAX-1107), supports 5.25" to 8.5" Poles
PMAX-0513		Pole Mount (for Z950, Z952)
PMAX-0702		Junction Box for PTZ and Dome Cameras
PMAX-0711		Junction box (for Z950, Z952)
PMAX-0807		Gangbox Converter (for PMAX-0102, PMAX-0312, PMAX-0313, PMAX-0314, PMAX-0321), supports Two-Gang Boxes
PMAX-1403		Ceiling Mount (for Z950, Z952)

Note: Some mounting accessories may need additional accessories for installation. Please check www.acti.com/mountingselector for more information.

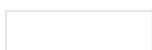

Power Supply Accessories - PoE Injector

PPOE-0101  High PoE Injector IEEE 802.3at compliant, AC 100~240V, with universal connectors (for A416, A418, B913, B923, B934, Q450, Q75, VMGB-400, VMGB-603, VMGB-604, Z36, Z37, Z71, Z710, Z952)

PPOE-0106  High PoE Injector IEEE 802.3at compliant, AC 100~240V, with universal connectors (for A416, A418, B913, B923, B934, Q450, Q75, VMGB-60X, Z37, Z71, Z952)

Audio Devices - Microphone

PMIC-0100  Active Microphone Omnidirectional for all Cameras with Line-in Audio

